



## Draining and shower systems

The Special Profiles program for drainage systems allows you to solve the most different situations. Simple and economical drainage wells for laundries or service areas. Water drainage systems for showers, with square or rectangular shapes, with multiple sizes available. The systems can be used with the supplied grids, with a modern and captivating design, or with the tile holder system, for a “concealed” system. All our drainage systems are 100% guaranteed for strength, functionality and durability. All our products are equipped with mats / insulation membranes, accessories for cleaning the system and all are equipped with a siphon.

Easy to install and maintain, sturdy for an excellent long-lasting result.

- Material: Aisi 304 steel - ABS
- Glossy finish
- Dimensions: as per technical data sheets
- Quantity per pack: as per technical data sheets

	Dimensioni Size			Quantità per conf. Packing Quantity
<b>SPECIALDRAIN</b>	mm	Cod. Art./Item Code	€/pz	pz/pcs

**ACCIAIO STEEL**

100x100	SPCD1010IL00		16
---------	--------------	--	----

**CHIUSINO 10x10 REGOLABILE CON GRIGLIA INOX**

Corpo e sifone in ABS, Griglia in acciaio inox.

**ADJUSTABLE 10x10 FLOOR DRAIN WITH INOX GRATING**  
 Body and siphon in ABS - Grating in stainless steel Aisi 304

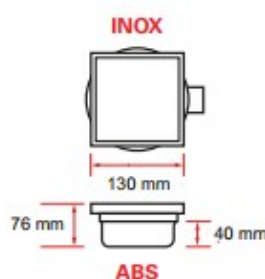

<b>SPECIALDRAIN</b>	130x130	SPCD1313IL00		12
---------------------	---------	--------------	--	----

**ACCIAIO STEEL**

**CHIUSINO REGOLABILE CON PORTAPIASTRELLA INOX**

Acciaio 130x130

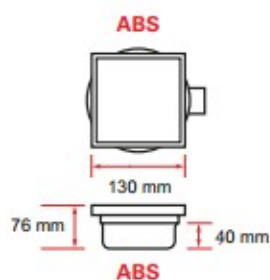
**ADJUSTABLE INOX FLOOR DRAIN**  
 with tile tray 130x130

<b>SPECIALDRAIN</b>	130x130	SPCD1313PV00		20
---------------------	---------	--------------	--	----

**ABS ABS**

**CHIUSINO REGOLABILE CON PORTAPIASTRELLA ABS**

ABS 130x130

**ADJUSTABLE ABS FLOOR DRAIN**  
 with tile tray 130x130

Dimensioni Size	Portata Water flow			Quantità per conf. Packing Quantity
mm	lpm	Cod. Art./Item Code	€/pz	pz/pcs

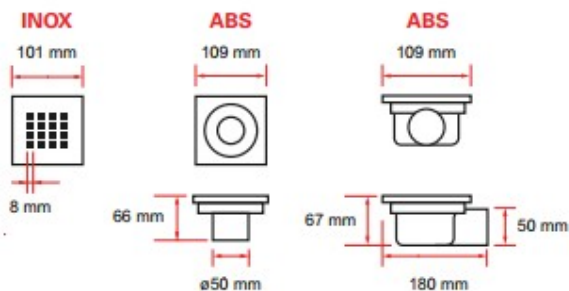
SPECIALDRAIN				
ACERO ACIER	100x100	200	SPCD1010ILOG	1



#### CHIUSINO 10x10 PER DOCCIA INOX

Griglia 16 fori, vaschetta e corpo sifonato

#### SHOWER DRAIN 10x10 INOX

16 holes grid, drain body and siphon body

Il Kit comprende il corpo sifonato, il foglio di guaina impermeabilizzante con adattatore incorporato, la vaschetta, il filtro e la griglia.

Materiale:

- Vaschetta in PVC
- Corpo sifonato e filtro in ABS
- Griglia e cornice della vaschetta in Acciaio INOX

The kit includes the siphon body, the waterproofing sheet with builtin adapter, the drain body, the filter and the grid.

Material:

- Drain body, adapter and filter in ABS.
- Grid and body frame in stainless steel AISI 304.
- Waterproofing sheet composed of two external layers of polypropylene + an inner layer of polyethylene.

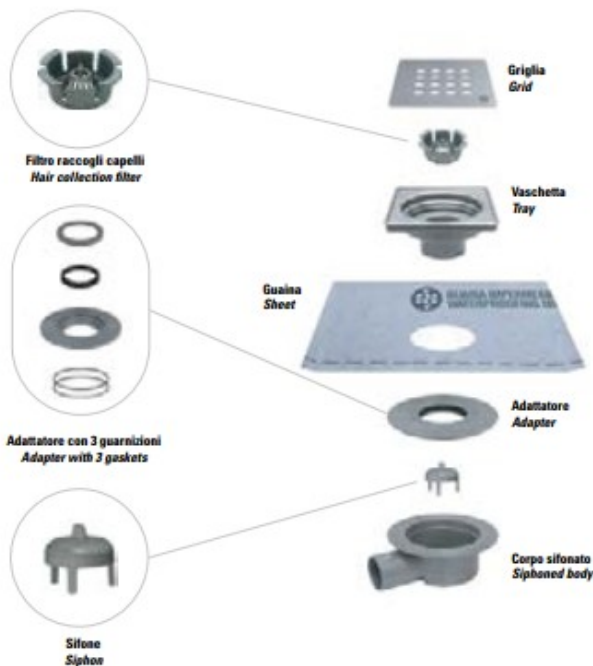

Chiavetta per la rimozione della griglia inclusa  
Key for removing the grille included



Filtro rimovibile  
Removable filter



Uscita  $\varnothing 50$   
 $\varnothing 50$  outlet

Dimensioni Size	Portata Water flow			Quantità per conf. Packing Quantity
mm	lpm	Cod. Art./Item Code	€/pz	pz/pcs

SPECIALLINEARG				
ACERO ACIER	656x52	200	SPCL0065ILOG	1

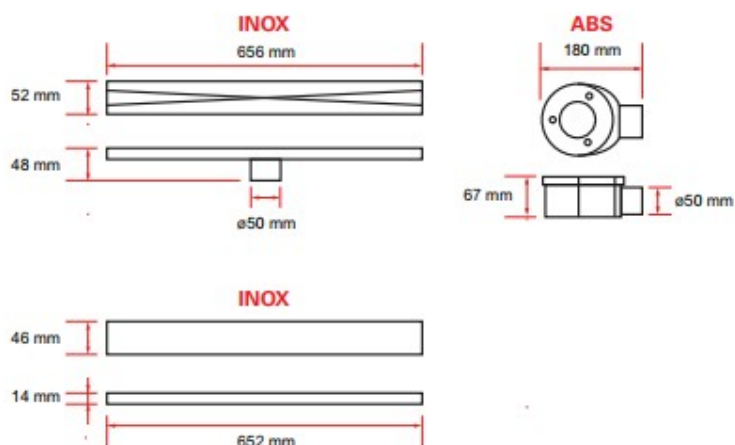

### CANALETTA PER DOCCIA CON GRIGLIA INOX LINEAR SHOWER DRAIN WITH INOX GRATING

Il Kit comprende il corpo sifonato, il foglio di guaina impermeabilizzante con adattatore incorporato, la vaschetta, il filtro e la griglia.

Materiale:

- Vaschetta in PVC
- Corpo sifonato e filtro in ABS
- Griglia e cornice della vaschetta in Acciaio INOX
- Waterproofing sheet composed of two external layers of polypropylene + an inner layer of polyethylene.

The kit includes the siphon body, the waterproofing sheet with builtin adapter, the drain body, the filter and the grid.

Material:

- Drain body, adapter and filter in ABS.
- Grid and body frame in stainless steel AISI 304.
- Waterproofing sheet composed of two external layers of polypropylene + an inner layer of polyethylene.



Chiavetta per la rimozione della griglia inclusa  
Key for grille removal included



Filtro rinnovabile  
Removable filter



Uscita ø50  
Ø50 outlet

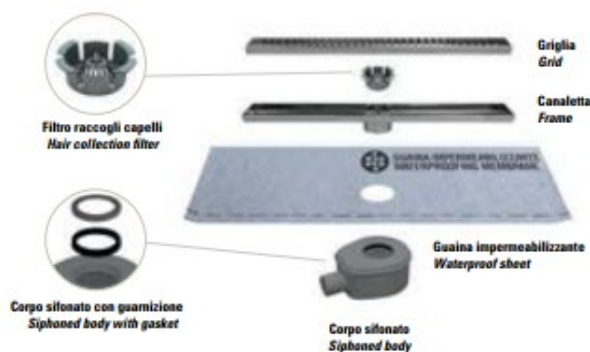

Disponibili anche le lunghezze 550 mm e 750 mm  
Other length available 550 mm e 750 mm



Dimensioni Size	Portata Water flow			Quantità per conf. Packing Quantity
mm	lpm	Cod. Art./Item Code	€/pz	pz/pcs

<b>SPECIALLINEARG</b>	658x53	200	SPCLA065IL0G		1
	<b>ACCIAIO STEEL</b>				

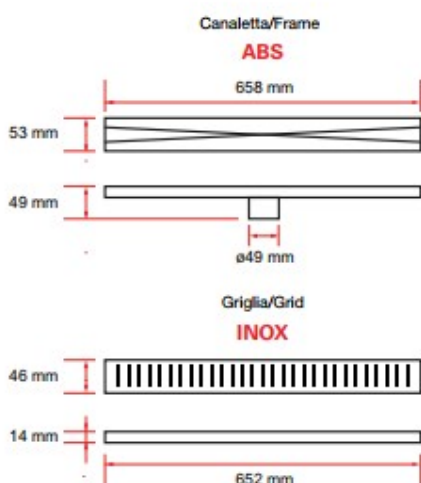

**CANALETTA PER DOCCIA CON GRIGLIA INOX  
LINEAR SHOWER DRAIN WITH INOX GRATING**

Il Kit comprende il corpo sifonato, il foglio di guaina impermeabilizzante con adattatore incorporato, la vaschetta, il filtro e la griglia.

Materiale:

- Vaschetta in PVC
- Corpo sifonato, canaletta e filtro in ABS
- Griglia INOX
- Waterproofing sheet composed of two external layers of polypropylene + an inner layer of polyethylene.

The kit includes the siphon body, the waterproofing sheet with builtin adapter, the drain body, the filter and the grid.

Material:

- Drain body, frame adapter and filter in ABS.
- Grid in stainless steel AISI 304.
- Waterproofing sheet composed of two external layers of polypropylene + an inner layer of polyethylene.



Chiavetta per la rimozione della griglia inclusa  
Key for grille removal included

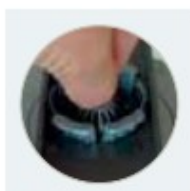

Filtro rimovibile  
Removable filter



Uscita ø50  
Ø50 outlet



Disponibili anche le lunghezze 550 mm e 750 mm  
Other length available 550 mm e 750 mm

Dimensioni Size	Portata Water flow			Quantità per conf. Packing Quantity
mm	lpm	Cod. Art./Item Code	€/pz	pz/pcs

<b>SPECIALINEARPG</b>	656x52	200	SPCL0065ILPG		1
	<b>ACCIAIO STEEL</b>				

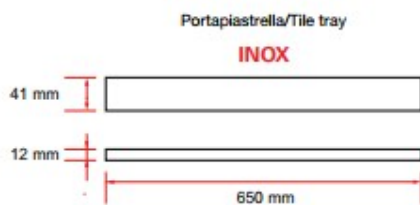
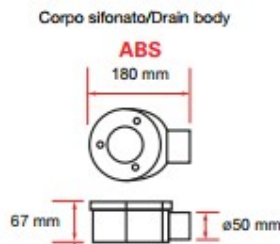
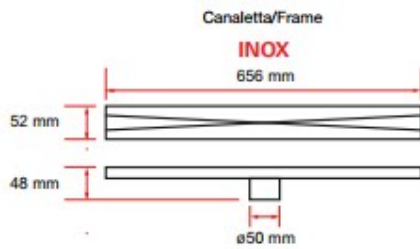

### CANALETTA PER DOCCIA CON PORTAPIASTRELLE INOX LINEAR SHOWER DRAIN WITH INOX TILE TRAY

Il Kit comprende il corpo sifonato, il foglio di guaina impermeabilizzante con adattatore incorporato, la vaschetta, il filtro e il portapiastrella.

Materiale:

- Corpo sifonato e filtro in ABS
- Canaletta e portapiastrella in Acciaio INOX

*The kit includes the siphon body, the waterproofing sheet with builtin adapter, the drain body, the filter and the tile tray.*

*Material:*

- Drain body, adapter and filter in ABS.
- Tile tray and body frame in stainless steel AISI 304.
- Waterproofing sheet composed of two external layers of polypropylene + an inner layer of polyethylene.



Filtro rimovibile  
Removable filter



Uscita ø50  
50 outlet



Il porta piastrella è dotato di fermi in gomma  
The tile holder is equipped with rubber stops

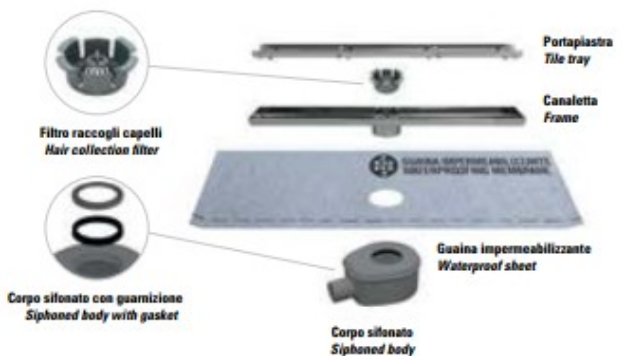

Disponibili anche le lunghezze 550 mm e 750 mm  
Other length available 550 mm e 750 mm

SPECIALINEARPG	Dimensioni Size	Portata Water flow	Cod. Art./Item Code	€/pz	Quantità per conf. Packing Quantity
	mm	lpm			pz/pcs
ACCIAIO STEEL					
	658x53	200	SPCLA065ILPG		1

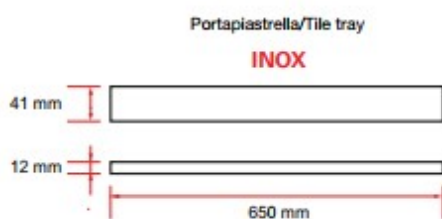
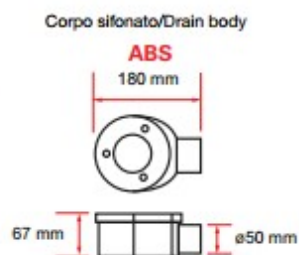
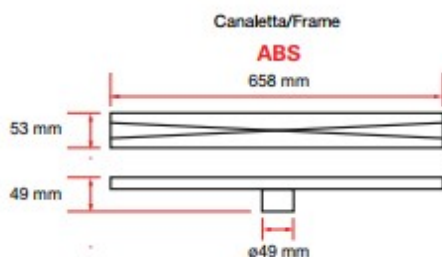

### CANALETTA PER DOCCIA CON PORTAPIASTRELLA INOX LINEAR SHOWER DRAIN WITH INOX TILE TRAY

Il Kit comprende il corpo sifonato, il foglio di guaina impermeabilizzante con adattatore incorporato, la vaschetta, il filtro e il portapiastrella.

Materiale:

- Corpo sifonato, canaletta e filtro in ABS
- Portapiastrella in INOX

The kit includes the siphon body, the waterproofing sheet with builtin adapter, the drain body, the filter and the tile tray.

Material:

- Drain body, adapter frame and filter in ABS.
- Tile tray in stainless steel AISI 304.

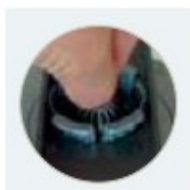

Filtro rimovibile  
Removable filter



Uscita ø50  
Ø50 outlet



Disponibili anche le lunghezze 550mm e 750mm  
Other length available 550mm e 750mm

Dimensioni Size	Densità Density	m <sup>2</sup> x rotolo m <sup>2</sup> x roll		rotolo roll	Quantità per conf. Packing Quantity	
WATERPROOF LAYER	m	g/m <sup>2</sup>	m <sup>2</sup>	Cod. Art./Item Code	€	pz/pcs
GUAINA SHEATH	1,2x5	300	6	SPMEM5012ROLL		1

**MATERIALE:**

Guaina composta da due strati di poliolefine EVAC + uno strato di fibra di PP.

**MATERIAL:**

Membrane composed of two layers of EVAC + a layer of PP fibre.



Imballo  
Packing



A  
n-

**Main characteristics of the raw materials used by Special Profiles**

**ALUMINUM**

Aluminum alloy (Al-Mg-Si) The profiles are made by extrusion or lamination and subsequent press bending. They have excellent resistance to the main chemical and atmospheric agents. Surface treatments through the company's proprietary systems, transform the material into:  
Anodized aluminum: anodic oxidation with 8-10 microns of oxide thickness.  
Polished Aluminum: anodic oxidation with 8-10 microns of oxide thickness.  
Painted Aluminum: powder coated, with about 100 microns of paint thickness.  
Not recommended for floor use.

**STAINLESS STEEL - AISI 304**

The profiles are made by rolling and subsequent press bending. They have excellent resistance to the main chemical and atmospheric agents and excellent mechanical resistance  
Surface treatments through the company's systems, transform the material into:  
Polished and bright steel. Use both on the wall and on the floor, in hospitals, food, industry.  
• Attention: the cutting edges are not stainless

**Rigid PVC** (Corner protectors)

Lead-free, impact-resistant, self-extinguishing rigid vinyl chloride. Good mechanical and abrasion resistance.

**Co-extruded PVC** - Rigid / Soft (expansion joints)



Co-extruded rigid vinyl chloride with soft PVC, leadfree, shockproof, self-extinguishing. Excellent mechanical resistance, to abrasion.

**PE-HD** (Tile spacers)

High density polyethylene, thermoplastic resin, excellent chemical stability and mechanical resistance. The high density (HD) increases its stiffness.

**POLYPROPYLENE** (External square and round corners)

Thermoplastic polymer, semi-crystalline, with good mechanical and abrasion resistance.

**Maintenance**

Avoid direct contact with concrete and its derivatives, if wet, descaling products and detergents that contain chlorine. Avoid using abrasive products that can scratch (abrasive sponges / metal wool). Immediately after laying proceed with a thorough cleaning of the surfaces with plenty of water / neutral / non-alkaline PH products, in particular remove cement, glue from the exposed surfaces.

**Measures and tolerances**

All information and drawings contained in this catalog are non-binding and subject to change without notice.

All dimensional data refer to nominal dimensions, subject to mechanical tolerances, according to the En- 22768 ISO-2768 -m standard.

**Special Profiles codes/Descriptions**

**Raw Material**

A= Aluminium  
F= Iron  
P= PVC  
I= Steel  
O= Brass

**Colours**

A=Silver      B=Light Brown  
O=Gold      M=Brown  
N=Black  
B=White  
G=Gray

**Surface treatments**

N=Natural      Z=Zincked  
A=Anodized      L=Bright  
V=Painted      O=Matt  
P=Brushed      S=SuperBright  
B=Brilliant



*Special Profiles* a



*brand of Mecc.Al Group*



- Via dei Laghi, 4 - Calcinelli 61036 Colli al Metauro (PU) – Italia Tel. +39.0721.8764.163

Website : [www.special-profiles.com](http://www.special-profiles.com) e-mail: [specialprofiles@meccal.com](mailto:specialprofiles@meccal.com)