

Profili e Sistemi innovativi
Innovative Profiles and Systems

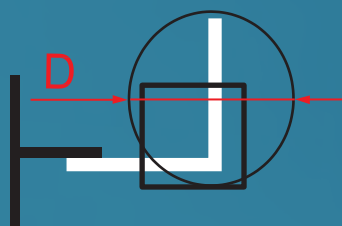

**SPECIAL
PROFILES**



Listino Prezzi 21/01
Price List 21/01

2021



Special Profiles

Special Profiles nasce dal know how e dall'esperienza trentennale di Mecc.Al, azienda leader mondiale nella progettazione e produzione di Alluminio. Col nuovo brand "Special Profiles", realizza e distribuisce una gamma completa di profili e lamiere per i settori del Fai da Te, posa dei pavimenti e rivestimenti, sia a livello civile che industriale, in tutto il mondo.

Special Profiles

Special Profiles was born from the know-how and thirty year experience of Mecc.Al, a world leader in the design and production of aluminum. With the new brand "Special Profiles", it creates and distributes a complete range of profiles and metal sheets for the DIY sectors, laying floors and walls, both civil and industrial, worldwide.

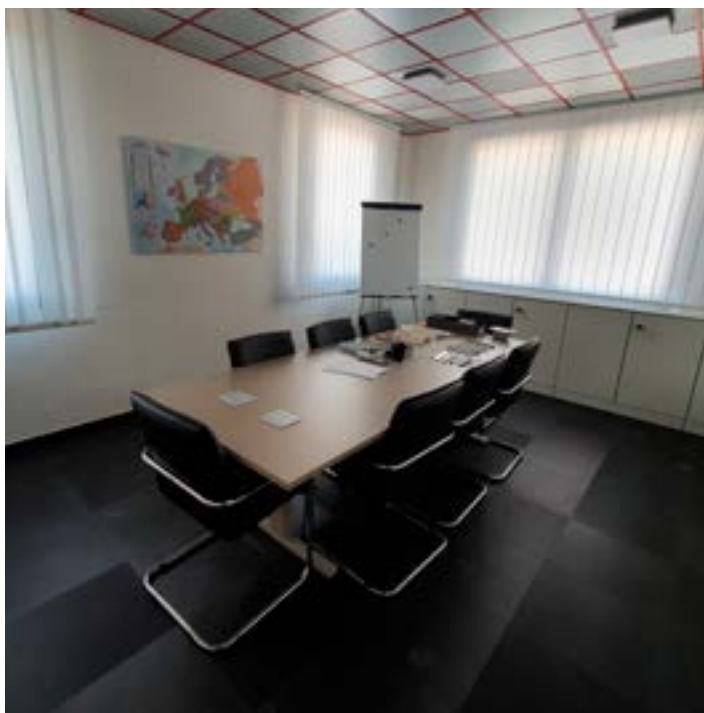

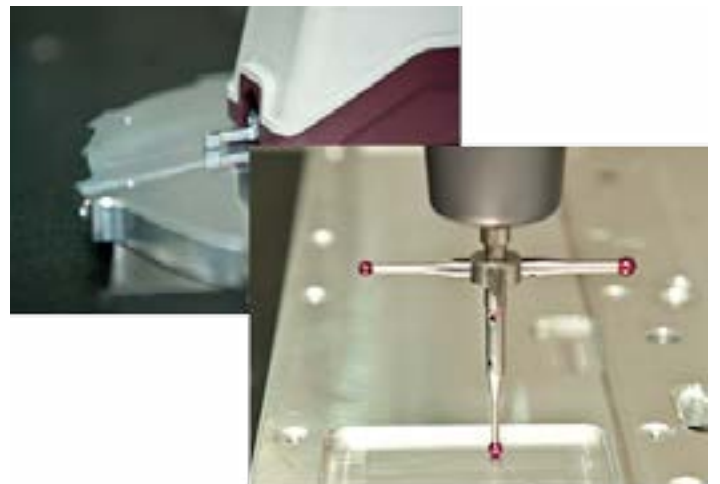

Special Profiles

sfruttando le enormi risorse del Gruppo di appartenenza, parte dalle materie prime per produrre in autonomia tutti i semilavorati necessari per la produzione dei prodotti finiti. Qualità, Flessibilità, Affidabilità, Competitività sono alcuni dei vantaggi a Vostra disposizione.

Using the huge resources of the Group to which it belongs, Special Profile starts from raw materials to independently produce all the semi-finished products necessary for the production of finished products. Quality, Availability, Flexibility, Reliability, are some of the advantages available to you.

Special Profiles

utilizza per la produzione dei prodotti macchine e sistemi di ultima generazione: anche tutti i trattamenti superficiali sono realizzati al suo interno. Un magazzino efficace ed efficiente, unitamente ad una logistica all'avanguardia, permettono consegne entro le 48 ore dall'ordine.

Special Profiles entirely produces its products within the Company, guaranteeing Quality and Service. Thanks to the latest generation of machines and systems, all surface treatments are also carried out internally. An effective and efficient warehouse, together with cutting-edge logistics, allow deliveries within 48 hours.





Servizio Clienti

L'intero team Special Profiles è a Vostra completa disposizione per qualsiasi tipo di suggerimento e supporto. Grazie alla nostra rete capillare di agenti su tutto il territorio potete beneficiare di un immediato contatto professionale. Il tutto supportato anche dal nostro personale interno. Non esitate a contattarci, usando i nostri riferimenti.

Customer Care

The whole Special Profiles team is at your complete disposal for any suggestion and support. Thanks to our network of agents throughout the territory, you can benefit from immediate professional contact. All supported also by our internal staff. Do not hesitate to contact us, using our references.



Tel. +39 0721 876 4201 (IT)

Tel. +39 0721 876 4202 (EN)

E-Mail specialprofiles@meccal.com

Web www.special-profiles.com



**QUALITY SYSTEM
CERTIFICATION
DNV-GL
ISO 9001**

**QUALITY SYSTEM
CERTIFICATION
DNV-GL
IATF 16949**

**QUALITY SYSTEM
CERTIFICATION
DNV-GL
ISO 14001**



Le certificazioni per la Qualità Quality certifications

La ricerca della qualità in tutti gli aspetti della produzione è uno dei punti fondamentali di Special Profiles, certificata dall'ente internazionale DNV secondo la norma UNI EN ISO 9001:2015, grazie anche ad un'accurata politica di selezione e controllo rivolta verso i nostri partner e fornitori.

Un prodotto di alta qualità, affidabile ed esauriente, la capacità manifatturiera, il personale dedito e qualificato ed il rispetto rigoroso dei celeri tempi di consegna sono i punti di forza di Special Profiles, partner ideale per tutte le esigenze nell'ambito dei Profili per il fai da te, per le costruzioni, per la posa di pavimenti e rivestimenti.

Il nostro impegno nella qualità si rivolge allo stesso tempo al rispetto della salute umana ed ambientale, offrendo prodotti conformi alle direttive RoHS e REACH che limitano la presenza di sostanze pericolose nella produzione : la nostra certificazione ISO 14001 ne è la prova tangibile.

The search for quality in all aspects of production is one of the fundamental points of Special Profiles, certified by the DNV international body, according to the UNI EN ISO 9001: 2015 standard, thanks also to an accurate selection and control policy aimed at our partners and suppliers. A high quality, reliable and comprehensive product, manufacturing capacity, dedicated and qualified staff and rigorous respect for fast delivery times are the strength of Special Profiles, the ideal partner for all needs in the field of Profiles for do-it-yourself, construction, for laying floors and walls.

Our commitment to quality is aimed at the same time to respect human and environmental health, offering products compliant with the RoHS and REACH directives which limit the presence of dangerous substances in production: our ISO 14001 certification is tangible proof of this.

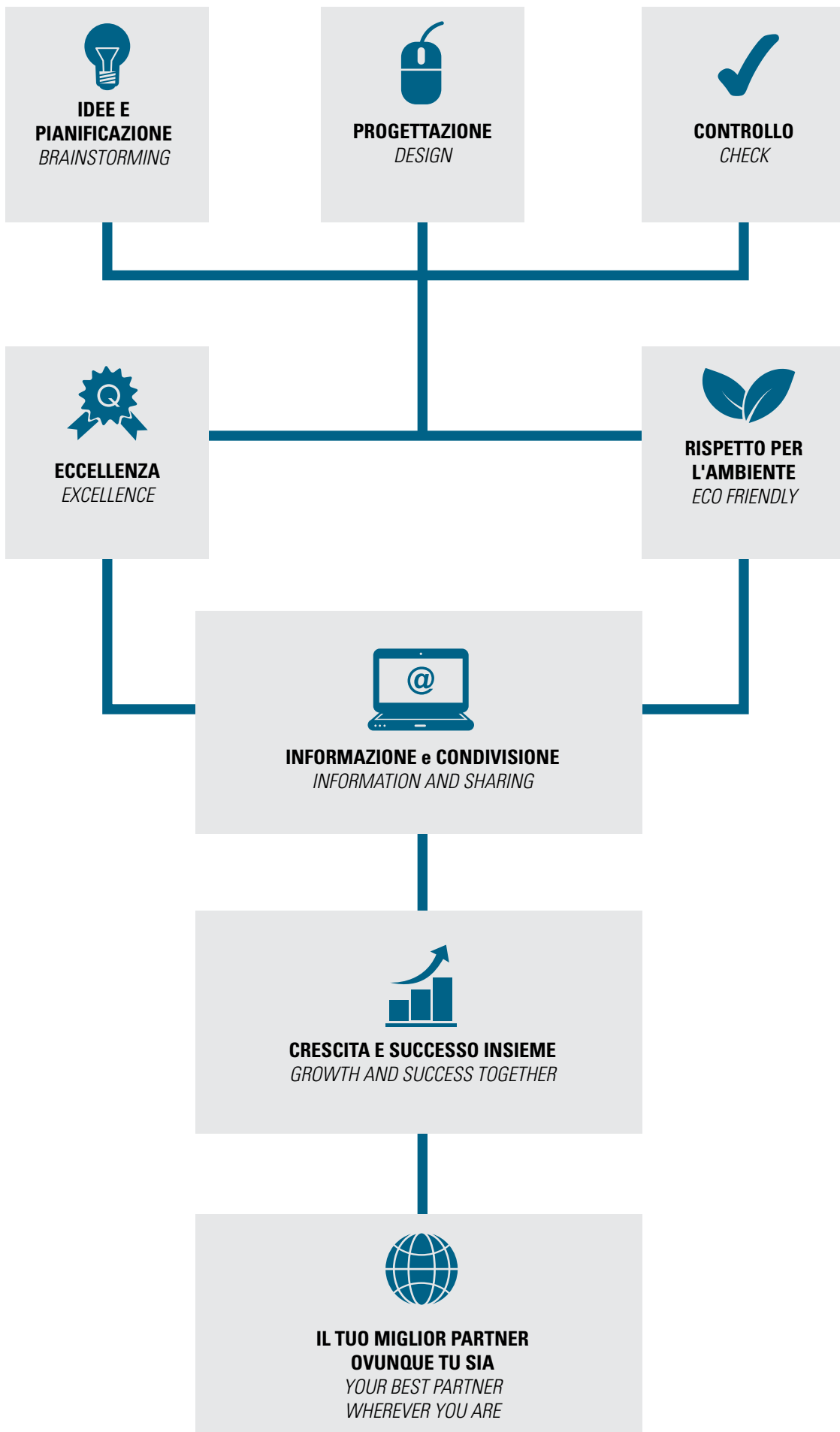

pag. 8

Profili per rivestimenti

Profiles for coverings



pag. 19

Profili per pavimenti

Profiles for Floors



pag. 28

Profili per gradini

Stair nosing profiles



pag. 30

Battiscopa

Skirting boards



pag. 33

Profili per balconi e terrazzi

Edging Profiles for terraces and balconies



pag. 39

Sistemi di drenaggio

Draining and shower systems



pag. 47

Giunti di dilatazione, Accessori per la posa

Accessories for laying movement joints



pag. 51

Profili per il fai da te DIY Profiles

Alluminio/Aluminium

pag. 61

Acciaio/Steel

pag. 65

Ferro/Iron

pag. 71

Lamiere/Sheets



pag. 77

Sistemi espositivi e proposte di Vendita

Display systems and sales proposals



pag. 92

Imballi-Etichette-Materiali-Condizioni di vendita

Packing-Labels-Materials-Terms of sale



SPECIAL
PROFILES

Profili per Rivestimenti
Profiles for Tiles



Spessore Thickness T	Dimensioni Size H	Lunghezza Length	Cod. Art./Item Code	Profili Anodizzati Argento Silver Anodized Profiles				Quantità per conf. Packing Quantity
				Satinato Silver AAA	Brillante Bright Silver ABA	€/m	€/pz	
SPECIAL ROUND AL	mm	mm	m			€/m	€/pz	pz/pcs

ALLUMINIO ALUMINIUM



1	6	2,7	SPRO00061AAA27					10
			SPRO00061ABA27					
	8		SPRO00081AAA27					
			SPRO00081ABA27					
	10		SPRO00101AAA27					
			SPRO00101ABA27					
			SPRO00121AAA27					
12,5	SPRO00121ABA27							

ESTRUSO / EXTRUDED



0,7	8	2,7	SPRO00087AAA27					10
			SPRO00087ABA27					
	10		SPRO00107AAA27					
			SPRO00107ABA27					
	12,5		SPRO00127AAA27					
			SPRO00127ABA27					

PRESSOPIEGATO / PRESS-BENDED

Dimensioni Size H	completa il cod. art. (x) con il tipo di prodotto A o B complete item code (x) with the product type A or B	Anodizzati Argento Silver Anodized		Quantità per conf. Packing Quantity
		Satinato Silver AAA	Brillante Bright Silver ABA	
SPECIALCAPSR-AL	Cod. Art./Item Code	€/pz	€/pz	

ALLUMINIO ALUMINIUM



8	SPCR0008AAA0x			10
	SPCR0008ABA0x			
10	SPCR0010AAA0x			
	SPCR0010ABA0x			
12	SPCR0012AAA0x			
	SPCR0012ABA0x			

A = Tappo semplice / Simple cap

A+B (a incastro) = Tappo per chiusura a 2 vie / (interlocking) 2-way closure cap

O-RING fornito per profilo spessore 0,7 mm / O-RING to use with profiles thickness 0,7 mm

SPECIAL ROUND AC	Spessore Thickness T	Dimensioni Size H	Lunghezza Length	Cod. Art./Item Code	Acciaio Lucido Polished Steel		Quantità per conf. Packing Quantity
	mm	mm	m		€/m	€/pz	pz/pcs

ACCIAIO STEEL

0,7	8	2,7	SPRO00087IL27			10
	10		SPRO00107IL27			
	12,5		SPRO00127IL27			
	15		SPRO00157IL27			

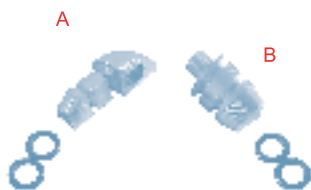

Dimensioni Size H	completa il cod. art. (x) con il tipo di prodotto A o B complete item code (x) with the product type A or B	Acciaio Lucido Polished Steel	Quantità per conf. Packing Quantity
mm	Cod. Art./Item Code	€/pz	

SPECIALCAPSR-AC
ACCIAIO STEEL

8	SPCR0008PVA0x		10
10	SPCR0010PVA0x		
12	SPCR0012PVA0x		

Dimensioni Size H	Lunghezza Length	Cod. Art./Item Code	PVC bianco White PVC		Quantità Packing
mm	m		€/m	€/pz	pz/pcs

SPECIALCAPSR-PVC
PVC PVC

6	2,60	SPRO0006PVB25			90
8		SPRO0008PVB25			
10		SPRO0010PVB25			
12		SPRO0012PVB25			

 Colori disponibili nella pagina seguente
 Other colours available on the next page

SPECIALCAPSR-PVC
PVC PVC

6		SPCR0006PB00			10
8		SPCR0008PB00			
10		SPCR0010PB00			
12		SPCR0012PB00			

 A = Tappo semplice / Simple cap
 A+B (a incastro) = Tappo per chiusura a 2 vie / (interlocking) 2-way closure cap
 O-RING fornito per profilo spessore 0,7 mm / O-RING to use with profiles thickness 0,7 mm



SpecialRound-PVC	Dimensioni Size H	Lunghezza Length	Cod. Art./Item Code	PVC colorato Colored PVC			Quantità Packing
	mm	m		colore/colour	€/m	€/pz	pz/pcs

PVC PVC

8	2,60	SPRO0008PVA26	Avorio/Ivory			60
10		SPRO0010PVA26				
8		SPRO0008PVR26	Rosa/Pink			
10		SPRO0010PVR26				
8		SPRO0008PVG26	Grigio/Grey			
10		SPRO0010PVG26				
8		SPRO0008PVC26	Celeste/Light blue			
10		SPRO0010PVC26				



SpecialRound-PVC	Dimensioni Size H	Lunghezza Length	Cod. Art./Item Code	PVC marmorizzato marbled PVC			Quantità Packing
	mm	m		colore/colour	€/m	€/pz	pz/pcs

PVC PVC



8	2,60	SPRO0008PVMO26	Rosa/Pink			60
10		SPRO0010PVMO26				
8		SPRO0008PVMP26	Rosa pesca/Peach pink			
10		SPRO0010PVMP26				
8		SPRO0008PVMB26	Beige chiaro/Light beige			
10		SPRO0010PVMB26				
8		SPRO0008PVMS26	Beige sabbia/Sand beige			
10		SPRO0010PVMS26				
8		SPRO0008PVMT26	Beige tabacco/Tobacco beige			
10		SPRO0010PVMT26				
8		SPRO0008PVMV26	travertino grigio/Travertine gray			
10		SPRO0010PVMV26				
8		SPRO0008PVME26	Crema/Yellow cream			
10		SPRO0010PVME26				
8		SPRO0008PVMN26	Travertino beige/Travertine beige			
10		SPRO0010PVMN26				
8		SPRO0008PVMD26	Verde/Green			
10		SPRO0010PVMD26				
8		SPRO0008PVMZ26	Verde brazil/Brazil green			
10		SPRO0010PVMZ26				
8	SPRO0008PVMI26	Grigio/ Grey				
10	SPRO0010PVMI26					





Spessore Thickness T	Dimensioni Size H	Lunghezza Length	Cod. Art./Item Code	Profili Anodizzati Argento Silver Anodized Profiles				Quantità per conf. Packing Quantity
				Satinato Silver AAA	Brillante Bright Silver ABA	€/m	€/pz	
SPECIAL SQUARE AL	mm	mm	m			€/m	€/pz	pz/pcs

ALLUMINIO ALUMINIUM



ESTRUSO / EXTRUDED

1	4,5	2,7	SPSQ00451AAA27					10
			SPSQ00451ABA27					
	6		SPSQ00061AAA27					
			SPSQ00061ABA27					
	8		SPSQ00081AAA27					
			SPSQ00081ABA27					
	10		SPSQ00101AAA27					
			SPSQ00101ABA27					
12,5	SPSQ00121AAA27							
	SPSQ00121ABA27							



PRESSOPIEGATO / PRESS-BENDED

0,7	8	2,7	SPSQ00087AAA27					10
			SPSQ00087ABA27					
	10		SPSQ00107AAA27					
			SPSQ00107ABA27					
	12,5		SPSQ00127AAA27					
			SPSQ00127ABA27					

Dimensioni Size H	completa il cod. art. (x) con il tipo di prodotto A o B complete item code (x) with the product type A or B	Anodizzati Argento Silver Anodized		Quantità per conf. Packing Quantity
		Satinato Silver AAA	Brillante Bright Silver ABA	
SPECIALCAPSQ-AL	Cod. Art./Item Code	€/pz	€/pz	

ALLUMINIO ALUMINIUM



8	SPCQ0008AAA0x			10
	SPCQ0008ABA0x			
10	SPCQ0010AAA0x			10
	SPCQ0010ABA0x			
12	SPCQ0012AAA0x			10
	SPCQ0012ABA0x			

A = Tappo semplice / Simple cap

A+B (a incastro) = Tappo per chiusura a 2 vie / (interlocking) 2-way closure cap

O-RING fornito per profilo spessore 0,7 mm / O-RING to use with profiles thickness 0,7 mm

SPECIAL SQUARE AC	Spessore Thickness T	Dimensioni Size H	Lunghezza Length	Cod. Art./Item Code	Acciaio Lucido Polished Steel		Quantità per conf. Packing Quantity
	mm	mm	m		€/m	€/pz	pz/pcs

ACCIAIO STEEL

0,7	8	2,7	SPSQ00087IL27			10
	10		SPSQ00107IL27			
	12,5		SPSQ00127IL27			



SPECIALCAPSQ-AC	Dimensioni Size H	completa il cod. art. (x) con il tipo di prodotto A o B complete item code (x) with the product type A or B	Acciaio Lucido Polished Steel	Quantità per conf. Packing Quantity
	mm	Cod. Art./Item Code	€/pz	

ACCIAIO STEEL

8	SPCQ0008ILOx	10
10	SPCQ0010ILOx	
12	SPCQ0012ILOx	

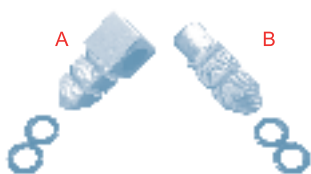

AL

**SPECIAL
PROFILES**
Profili per Rivestimenti

Profiles for Tiles

SPECIALTERM-AL	Spessore Thickness T	Dimensioni Size W	Lunghezza Length	Cod. Art./Item Code	Profili Anodizzati Argento Silver Anodized Profiles				Quantità per conf. Packing Quantity
					Satinato Silver AAA	Brillante Bright Silver ABA	€/m	€/pz	
	mm	mm	m		€/m	€/pz	€/m	€/pz	pz/pcs

ALLUMINIO ALUMINIUM

1	4,5	2,7	SPTTE0045AAA27					10
			SPTTE0045ABA27					
	6		SPTTE0006AAA27					
			SPTTE0006ABA27					
	8		SPTTE0008AAA27					
			SPTTE0008ABA27					
	10		SPTTE0010AAA27					
			SPTTE0010ABA27					
	12,5		SPTTE0012AAA27					
			SPTTE0012ABA27					
15	SPTTE0015AAA27							
	SPTTE0015ABA27							

AC

SPECIALTERM-AC	Spessore Thickness T	Dimensioni Size W	Dimensioni Size H	Lunghezza Length	Cod. Art./Item Code	Acciaio Lucido Polished Steel		Quantità per conf. Packing Quantity
						€/m	€/pz	
	mm	mm	mm	m		€/m	€/pz	pz/pcs

ACCIAIO STEEL

0,7	8	2,7	SPTTE00087IL27			10
	10		SPTTE00107IL27			
	12,5		SPTTE00127IL27			
	15		SPTTE00157IL27			

Spessore Thickness T	Dimensioni Size W	Lunghezza Length	Cod. Art./Item Code	Profili Anodizzati Argento Silver Anodized Profiles				Quantità per conf. Packing Quantity
				Satinato Silver AAA	Brillante Bright Silver ABA	€/m	€/pz	
SPECIAL CORNER AL	mm	mm	m	€/m	€/pz	€/m	€/pz	pz/pcs

ALLUMINIO ALUMINIUM

1	25	3	SPCO25251AAA27					10
			SPCO25251ABA27				16,02	

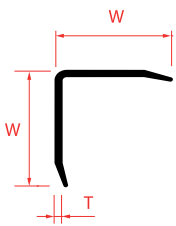

Spessore Thickness T	Dimensioni Size W	Dimensioni Size H	Lunghezza Length	Cod. Art./Item Code	Acciaio Lucido Polished Steel		Quantità per conf. Packing Quantity
mm	mm	mm	m		€/m	€/pz	pz/pcs
SPECIAL CORNER AC							

ACCIAIO STEEL

0,7	20		2,7	SPCO20207IL27			10
	30			SPCO30307IL27			

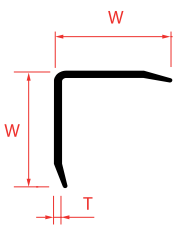

SpecialCornerPosa AC	0,7	30	8	2,7	SPCS30307IL08			10
			10		SPCS30307IL10			

ACCIAIO STEEL

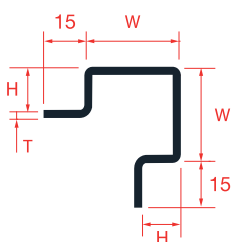



SPECIAL CORNER PVC	Spessore Thickness T	Dimensioni Size W	Lunghezza Length	Cod. Art./Item Code	PVC bianco White PVC		PVC marrone Brown PVC		Quantità per conf. Packing Quantity
	mm	mm	m		€/m	€/pz	€/m	€/pz	pz/pcs
PVC PVC	1	22	2,6	SPCO2222PVB26					110

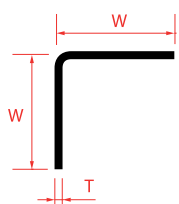

SPECIAL CORNER PVC	1	28	3	SPCO2828PVB03					20
PVC PVC				SPCO2828PVM03					

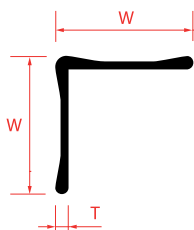



SPECIAL
PROFILES

Profili per Pavimenti
Profiles for Floors

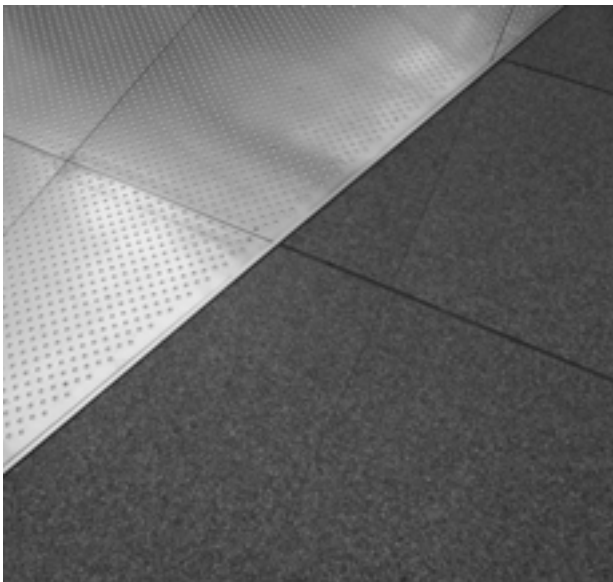

SPECIALSEMI-AL	Spessore Thickness T	Dimensioni Size WxH	Lunghezza Length	Cod. Art./Item Code	Naturale Natural	Profili Anodizzati Argento Silver Anodized Profiles				Quantità per conf. Packing Quantity
	mm	mm	m			€ /m	€ /pz	€ /m	€ /pz	pz /pcs

ALLUMINIO ALUMINIUM

1	30	2,70	SPSE00301AAA27						10
			SPSE00301ABA27						

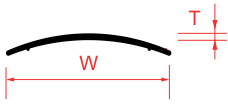

SPECIALSEMIFLAT-AL

ALLUMINIO ALUMINIUM

1,3	25	2,70	SPSF00251AAA27						10
			SPSF00251ABA27						

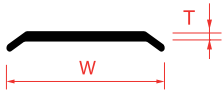

SPECIALTI-AL

ALLUMINIO ALUMINIUM

	14X9	2,70	SPTI1409AAA27						10
			SPTI1409ABA27						
	20X9		SPTI2009AAA27						
			SPTI2009ABA27						

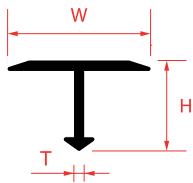

SPECIALBAND-AL

ALLUMINIO ALUMINIUM

	4,5X10	2,70	SPBA4510ANA27						10
			SPBA4510AAA27						
			SPBA4510ABA27						
	5X25		SPBA0525ANA27						
			SPBA0525AAA27						
			SPBA0525ABA27						

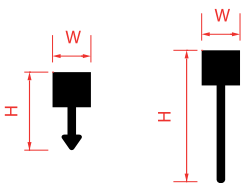



SPECIALTILT-AL	Spessore Thickness T	Dimensioni Size H	Lunghezza Length L	Cod. Art./Item Code	Profili Anodizzati Argento Silver Anodized Profiles				Quantità per conf. Packing Quantity
					Satinato Silver AAA	Brillante Bright Silver ABA	€/m	€/pz	

ALLUMINIO ALUMINIUM

1	10	2,7	SPTL0010AAA27					10
			SPTL0010ABA27					



SPECIALTERMILT-AL	Spessore Thickness T	Dimensioni Size H	Lunghezza Length L	Cod. Art./Item Code	Profili Anodizzati Argento Silver Anodized Profiles				Quantità per conf. Packing Quantity
ALLUMINIO ALUMINIUM					Satinato Silver AAA	Brillante Bright Silver ABA	€/m	€/pz	



	Spessore Thickness T	Dimensioni Size W - H	Lunghezza Length		Acciaio Lucido Polished Steel		Quantità per conf. Packing Quantity
SPECIALSEMI-AC	mm	mm	m	Cod. Art./Item Code	€/m	€/pz	pz/pcs

ACCIAIO STEEL

0,7	16	2,7	SPSE001671L27			10
	30		SPSE003071L27			

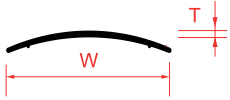

SPECIALSEMIFLAT-AC

0,7	25	2,7	SPSF002571L27			10
-----	----	-----	---------------	--	--	----

ACCIAIO STEEL

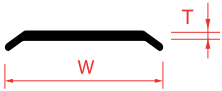

SPECIALTILT-AC

0,7	10	2,7	SPTL001071L27			10
-----	----	-----	---------------	--	--	----

ACCIAIO STEEL





	Spessore Thickness T	Dimensioni Size WxH	Lunghezza Length		Acciaio Lucido Polished Steel		Quantità per conf. Packing Quantity
SPECIALTERMILT-AC	mm	mm	m	Cod. Art./Item Code	€/m	€/pz	pz/pcs

ACCIAIO STEEL

0,7	10	2,7	SPTT001071L27			10
	12,5		SPTT001271L27			

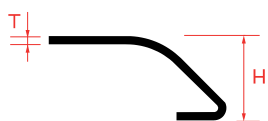

SPECIALTERMFLAT-AC	0,7	55x10	2,7	SPTF001071L27			10
---------------------------	-----	-------	-----	---------------	--	--	----

ACCIAIO STEEL





SPECIAL
PROFILES

Profili di raccordo igienici

Hygienic joint profiles

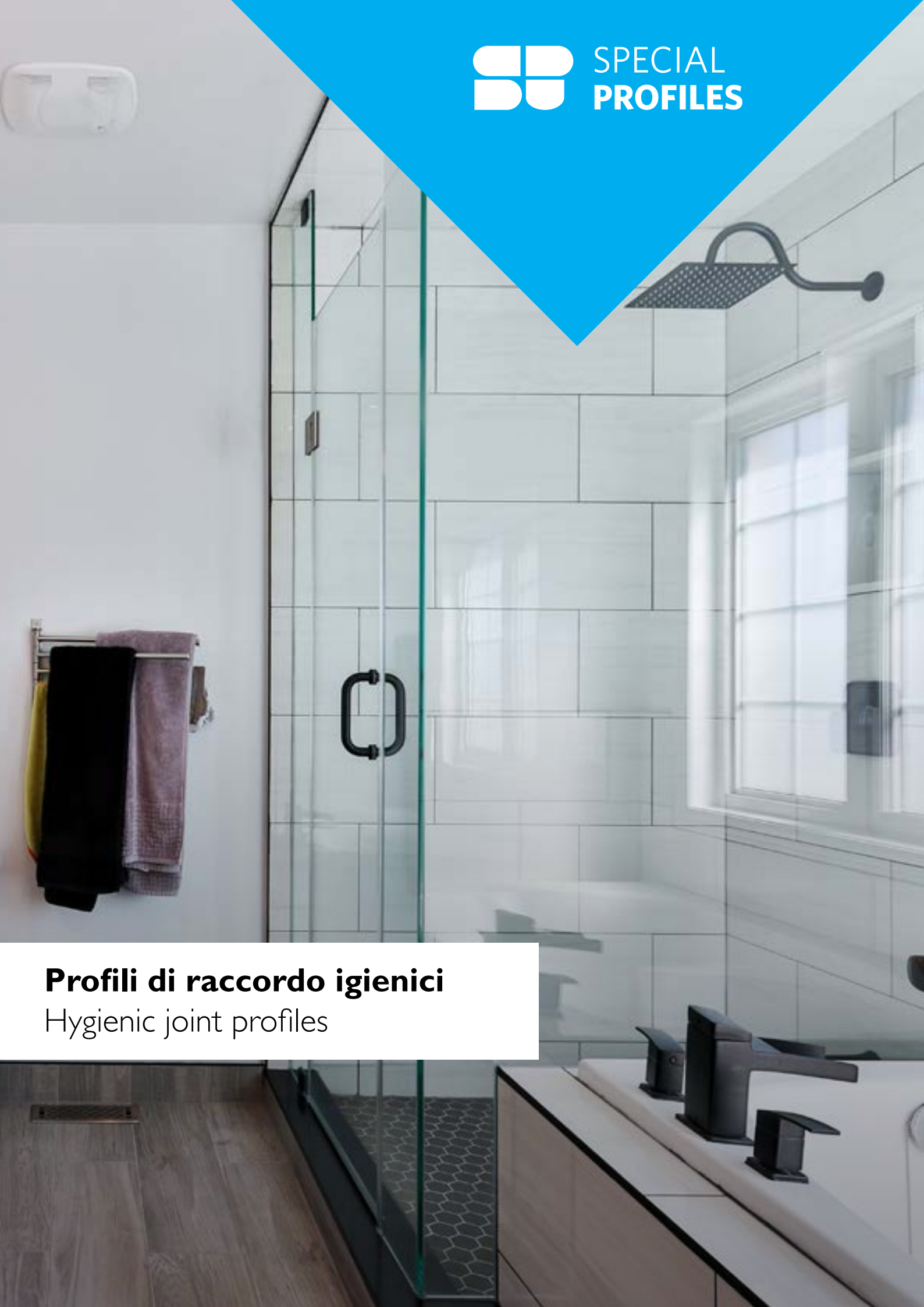



Dimensioni Size	Lunghezza Length	Cod. Art./Item Code	Profili Anodizzati Argento Silver Anodized Profiles				Quantità per conf. Packing Quantity
			Satinato Silver		Brillante Bright Silver		
mm	m		€/m	€/pz	€/m	€/pz	pz/pcs

SPECIALSANIT-AL		18x18	2,7	SPSA0020AAA27					10
ALLUMINIO ALUMINIUM						SPSA0020ABA27			

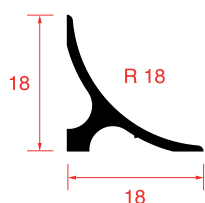

SPECIALPROTEC-AL		10x10	2,7	SPPR0010AAA27					10
ALLUMINIO ALUMINIUM						SPPR0010ABA27			

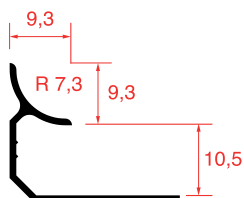

SPECIALSANIT-PVC	Dimensioni Size H	Lunghezza Length	Cod. Art./Item Code	PVC bianco White PVC		Quantità per conf. Packing Quantity
	mm	m		€/m	€/pz	pz/pcs
PVC PVC	45	2	SPSA4545PVB2			10

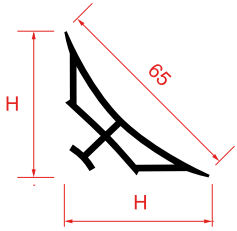

SPECIALPROTEC-PVC	8	2,6	SPPR0008PVB26			20
	PVC PVC	10	2,6	SPPR0010PVB26		

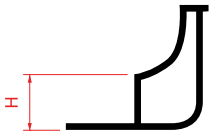

SpecialCapPI-PVC	8		SPPI0008PB00			10
	PVC PVC	10		SPPI0010PB01		



SpecialCapPE-PVC	8		SPPE0008PB00			10
	PVC PVC	10		SPPE0010PB01		





SPECIALSANIT-PVC	Dimensioni Size H	Lunghezza Length	Cod. Art./Item Code	PVC bianco White PVC		Quantità per conf. Packing Quantity
	mm	m		€/m	€/pz	pz/pcs
PVC PVC	20	2,5	SPSA2020PVB25			20

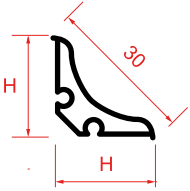

SPECIALCAPSI-PVC	20		SPCI2020PB00			10
------------------	----	--	--------------	--	--	----

PVC PVC



SPECIALCAPSE-PVC	20		SPCE2020PB00			10
------------------	----	--	--------------	--	--	----

PVC PVC



SPECIALSANIT-PVC	20		SPTR2020PB00			10
------------------	----	--	--------------	--	--	----

PVC PVC





SPECIAL
PROFILES

Profili per gradini

Stair nosing profiles

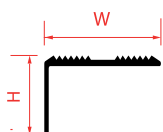

SPECIALSTEP-AL	Dimensioni Size WxH mm	Lunghezza Length m	Cod. Art./Item Code	Profili Anodizzati Argento Silver Anodized Profiles				Quantità per conf. Packing Quantity pz/pcs
				Satinato Silver AAA €/m €/pz		Brillante Bright Silver ABA €/m €/pz		

ALLUMINIO ALUMINIUM

25x20	2,7	SPST2520AAA27	3,92	10,58			10
		SPST2520ABA27			6,03	16,28	
42x26		SPST4226AAA27	5,41	14,61			
		SPST4226ABA27			8,02	21,65	

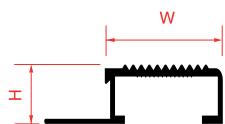
SPECIALSTEPSQ-AL
ALLUMINIO ALUMINIUM

20x10	2,7	SPSS0010AAA27					10
		SPSS0010ABA27					
20x12,5		SPSS0012AAA27					
		SPSS0012ABA27					

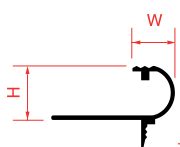
SPECIALSTEPROUND-AL
ALLUMINIO ALUMINIUM

10x10	2,7	SPSR0010AAA27					10
		SPSR0010ABA27					
10x12,5		SPSR0012AAA27					
		SPSR0012ABA27					





SPECIAL
PROFILES



Battiscopa
Skirting boards

AL

**SPECIAL
PROFILES**
Battiscopa
Skirting boards

SPECIALSKIRTING-AL	Spessore Thickness T	Dimensioni Size WxH	Lunghezza Length	Cod. Art./Item Code	Profili Anodizzati Argento Silver Anodized Profiles				Quantità per conf. Packing Quantity pz/pcs
	mm	mm	m		Satinato Silver AAA	Brillante Bright Silver ABA	€/m	€/pz	

ALLUMINIO ALUMINIUM

1,5	10x60	2	SPSK0060AAA27					20
			SPSK0060ABA27					

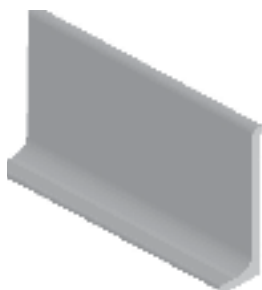
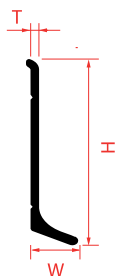

AC

SPECIALSKIRTING-AC	Spessore Thickness T	Dimensioni Size WxHxT	Lunghezza Length	Cod. Art./Item Code	Acciaio Lucido Polished Steel		Quantità per conf. Packing Quantity pz/pcs
	mm	mm	m		€/m	€/pz	

ACCIAIO STEEL

0,7	15x60	2	SPSK00607IL27				20
-----	-------	---	---------------	--	--	--	----

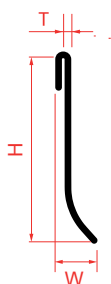



SPECIAL
PROFILES

Profili per Balconi e Terrazzi

Edging Profiles for Balconies and Terraces

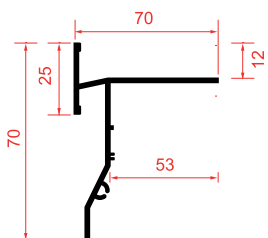

SpecialBord-AL	Dimensioni Size	Lunghezza Length	Cod. Art./Item Code	Naturale Natural	Anodizzati Anodized	Profili Verniciati Ral Ral Painted Profiles				Quantità per conf. Packing Quantity
					Argento Silver AAA	Bianco White 9010	Grigio Grey 7038	Beige Light Brown 1019	Marrone Brown 8019	
	mm	m		€/pz	€/pz	€/pz	€/pz	€/pz	€/pz	pz/pcs

ALLUMINIO ALUMINIUM

70x70x12	2,7	SPSB0012ANA27								10
		SPSB0012AAA27								
		SPSB0012AVB27								
		SPSB0012AVG27								
		SPSB0012AVE27								
		SPSB0012AVM27								

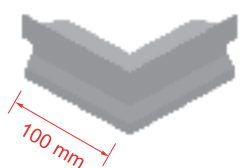
SpecialBordCorn-AL
ALLUMINIO ALUMINIUM

100x45°	0,1	SPSC0012ANA10								5
		SPSC0012AAA10								
		SPSC0012AVB10								
		SPSC0012AVG10								
		SPSC0012AVE10								
		SPSC0012AVM10								

2 angoli già assemblati, da 100 mm , taglio 45°.
2 corners, 100 mm each, 45°, pre mounted.

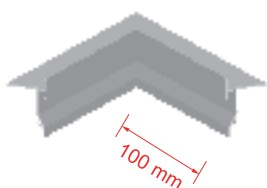
SpecialBordAng-AL
ALLUMINIO ALUMINIUM

100x45°	0,1	SPSD0012ANA10								5
		SPSD0012AAA10								
		SPSD0012AVB10								
		SPSD0012AVG10								
		SPSD0012AVE10								
		SPSD0012AVM10								

2 angoli già assemblati, da 100 mm , taglio 45°.
2 corners, 100 mm each, 45°, pre mounted.

Dimensioni Size		Acciaio Lucido Polished Steel	Quantità per conf. Packing Quantity
mm	Cod. Art./Item Code	€/per conf.	pz/pcs

SpecialBordPin-AC
ACCIAIO STEEL

200xø4	SPSP0004IL20		50
--------	--------------	--	----



Pin di connessione
Connection's Pin



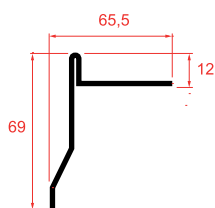

SpecialBordFlat-AL	Dimensioni Size	Lunghezza Length	Cod. Art./Item Code	Anodizzati Argento Silver Anodized	Profili Verniciati Ral Ral Painted Profiles				Quantità per conf. Packing Quantity	
				Satinato Silver AAA	Bianco White 9010	Grigio Grey 7038	Beige Light Brown 1019	Marrone Brown 8019		€/pz
	mm	m		€/pz	€/pz	€/pz	€/pz	€/pz	€/pz	pz/pcs

ALLUMINIO ALUMINIUM

65,5x69x12	2,7	SPSF0012AAA27						10
		SPSF0012AVB27						
		SPSF0012AVG27						
		SPSF0012AVE27						
		SPSF0012AVM27						

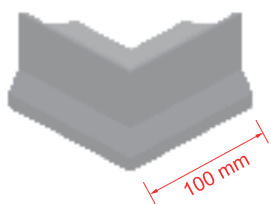
SpecialBordFlatCorn-AL
ALLUMINIO ALUMINIUM

100x45°	0,1	SPBC0007AAA10						5
		SPBC0007AVB10						
		SPBC0007AVG10						
		SPBC0007AVE10						
		SPBC0007AVM10						

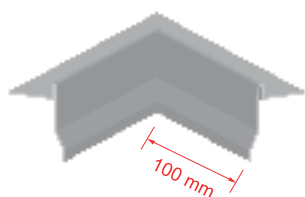
SpecialBordFlatAng-AL
ALLUMINIO ALUMINIUM

100x45°	0,1	SPBG0007AAA10						5
		SPBG0007AVB10						
		SPBG0007AVG10						
		SPBG0007AVE10						
		SPBG0007AVM10						

SpecialBordFlatConn-AL
ALLUMINIO ALUMINIUM



40	0,04	SPBN0007AAA04						50
		SPBN0007AVB04						
		SPBN0007AVG04						
		SPBN0007AVE04						
		SPBN0007AVM04						



	Dimensioni Size	Lunghezza Length		Acciaio Lucido Polished Steel	Quantità per conf. Packing Quantity
SpecialBordFlat-AC	mm	m	Cod. Art./Item Code	€/pz	pz/pcs

ACCIAIO STEEL

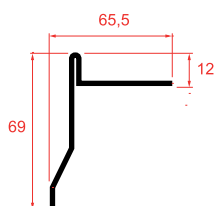
65,5x69x12	2,7	SPBF0007IL027		10
------------	-----	---------------	--	----



SpecialBordFlatCorn-AC

100x45°	0,1	SPBC0007IL10		5
---------	-----	--------------	--	---

ACCIAIO STEEL

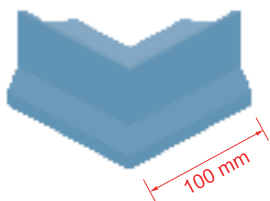

SpecialBordFlatAng-AC

100x45°	0,1	SPBG0007IL04		5
---------	-----	--------------	--	---

ACCIAIO STEEL

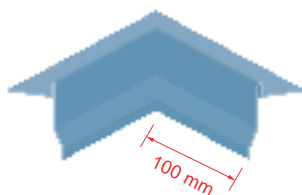

SpecialBordFlatConn-AC

40	0,4	SPBN0007IL04		50
----	-----	--------------	--	----

ACCIAIO STEEL

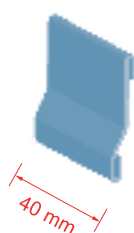

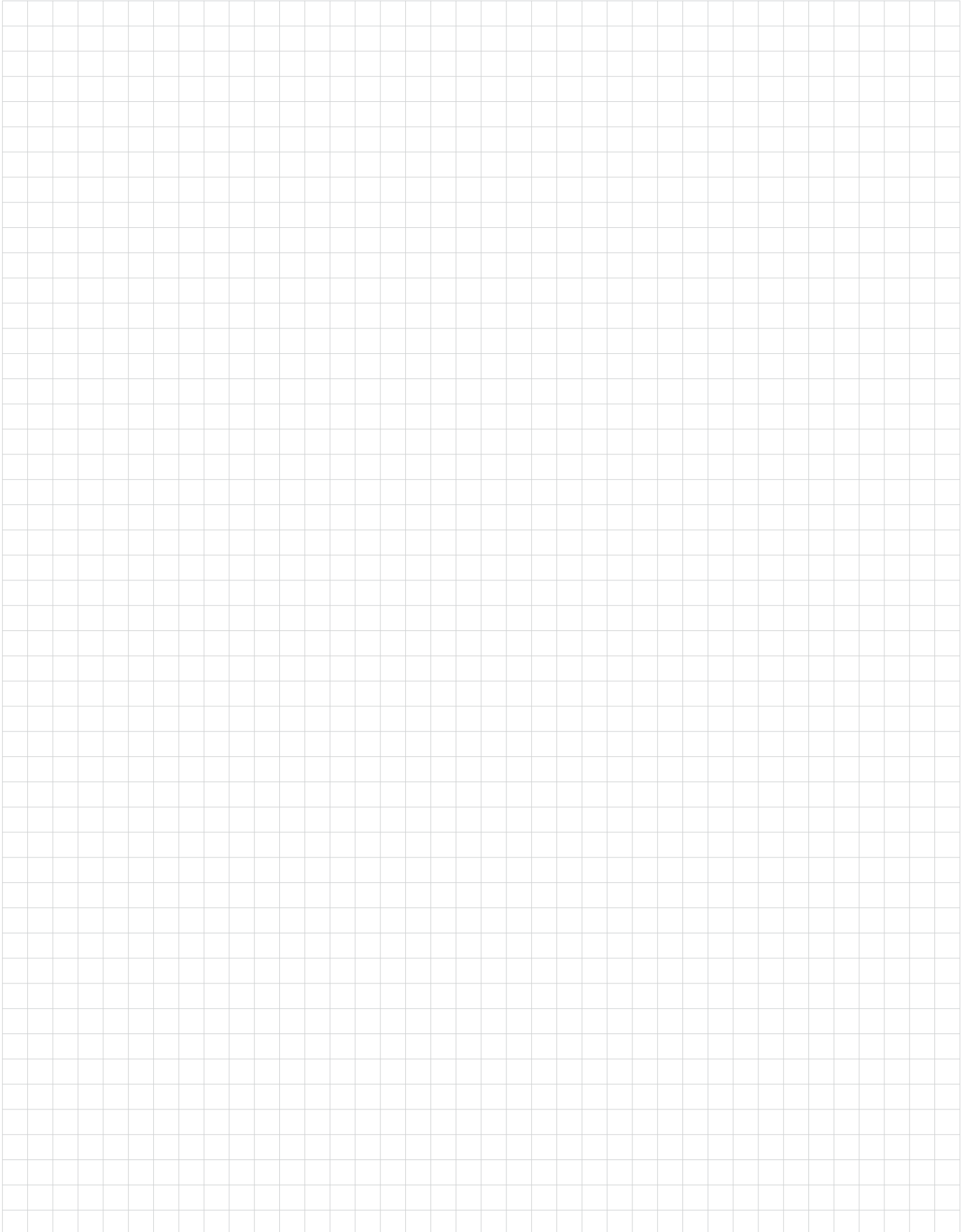



SPECIAL
PROFILES

Sistemi di drenaggio

Draining and shower systems



SPECIALDRAIN	Dimensioni Size	Cod. Art./Item Code	€/pz	Quantità per conf. Packing Quantity
	mm			pz/pcs

ACCIAIO STEEL

100x100	SPCD1010IL00		16
---------	--------------	--	----

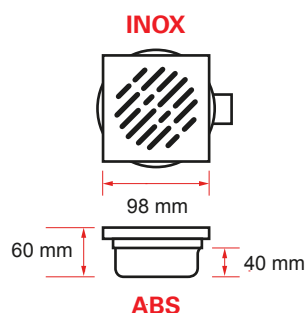

CHIUSINO 10X10 REGOLABILE CON GRIGLIA INOX

Corpo e sifone in ABS, Griglia in acciaio inox.

ADJUSTABLE 10x10 FLOOR DRAIN WITH INOX GRATING

Body and siphon in ABS - Grating in stainless steel Aisi 304



SPECIALDRAIN

ACCIAIO STEEL

130x130	SPCD1313IL00		12
---------	--------------	--	----

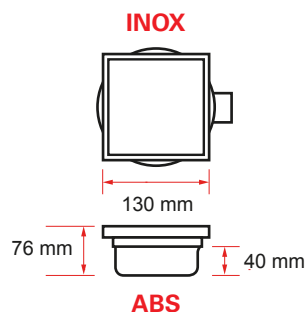

CHIUSINO REGOLABILE CON PORTAPIASTRELLA INOX

Acciaio 130x130

ADJUSTABLE INOX FLOOR DRAIN

with tile tray 130x130



SPECIALDRAIN

ABS ABS

130x130	SPCD1313PV00		20
---------	--------------	--	----

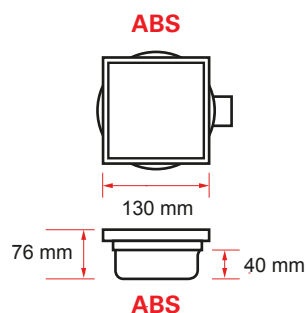

CHIUSINO REGOLABILE CON PORTAPIASTRELLA ABS

ABS 130x130

ADJUSTABLE ABS FLOOR DRAIN

with tile tray 130x130



Dimensioni Size	Portata Water flow			Quantità per conf. Packing Quantity
mm	lpm	Cod. Art./Item Code	€/pz	pz/pcs
SPECIALDRAIN ACERO ACIER	100x100	200	SPCD1010ILOG	1

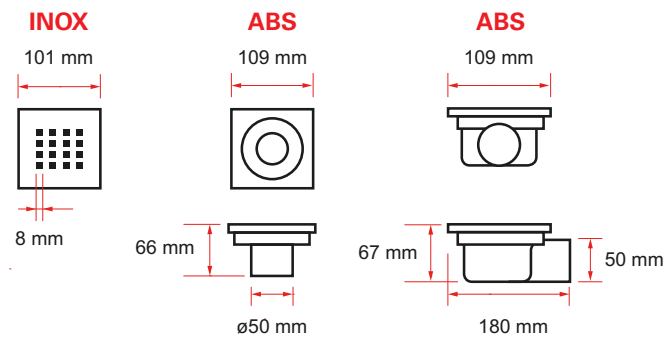

CHIUSINO 10x10 PER DOCCIA INOX
Griglia 16 fori, vaschetta e corpo sifonato

SHOWER DRAIN 10x10 INOX
16 holes grid, drain body and siphon body

Il Kit comprende il corpo sifonato, il foglio di guaina impermeabilizzante con adattatore incorporato, la vaschetta, il filtro e la griglia.
Materiale:
- Vaschetta in PVC
- Corpo sifonato e filtro in ABS
- Griglia e cornice della vaschetta in Acciaio INOX

The kit includes the siphon body, the waterproofing sheet with builtin adapter, the drain body, the filter and the grid.
Material:
Drain body, adapter and filter in ABS.
Grid and body frame in stainless steel AISI 304.
Waterproofing sheet composed of two external layers of polypropylene + an inner layer of polyethylene.

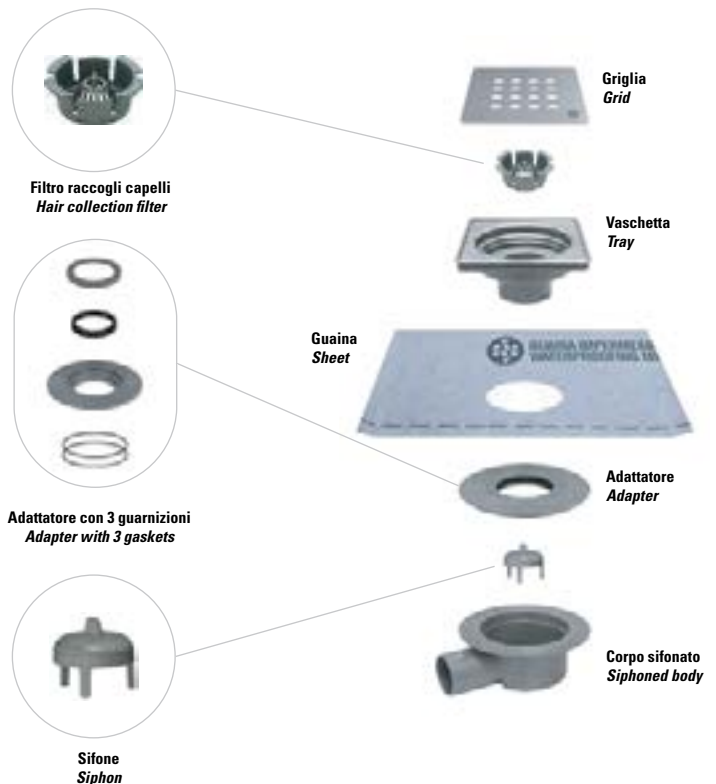

Chiavetta per la rimozione della groglia inclusa
Key for removing the grille included

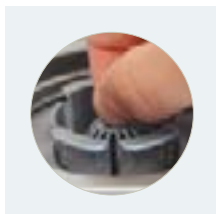

Filtro rimovibile
Removable filter



Uscita ø50
Ø50 outlet

Dimensioni Size	Portata Water flow			Quantità per conf. Packing Quantity
mm	lpm	Cod. Art./Item Code	€/pz	pz/pcs
SPECIALLINEARG				
ACERO ACIER	656x52	200	SPCL0065ILOG	1

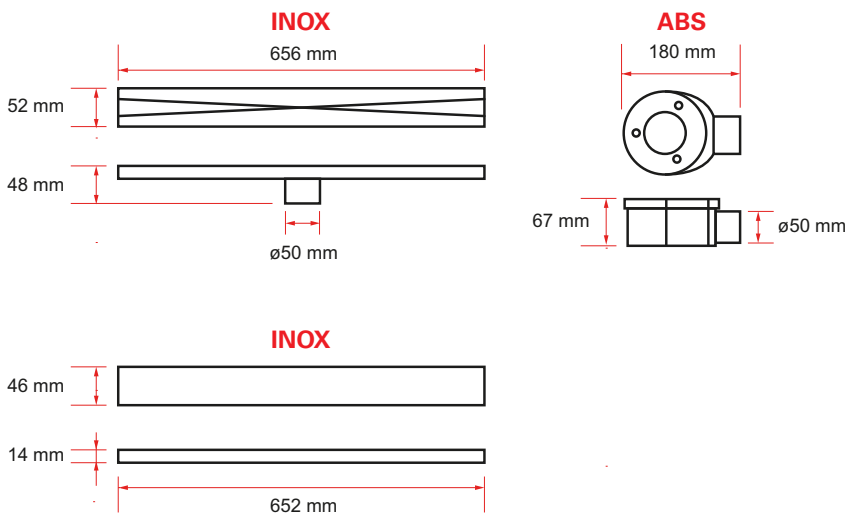

CANALETTA PER DOCCIA CON GRIGLIA INOX
LINEAR SHOWER DRAIN WITH INOX GRATING

Il Kit comprende il corpo sifonato, il foglio di guaina impermeabilizzante con adattatore incorporato, la vaschetta, il filtro e la griglia.

Materiale:

- Vaschetta in PVC
- Corpo sifonato e filtro in ABS
- Griglia e cornice della vaschetta in Acciaio INOX
- Waterproofing sheet composed of two external layers of polypropylene + an inner layer of polyethylene.

The kit includes the siphon body, the waterproofing sheet with builtin adapter, the drain body, the filter and the grid.

Material:

- Drain body, adapter and filter in ABS.
- Grid and body frame in stainless steel AISI 304.
- Waterproofing sheet composed of two external layers of polypropylene + an inner layer of polyethylene.

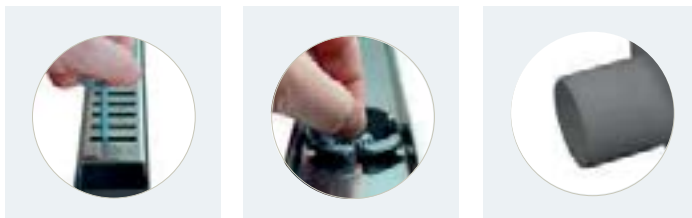

Chiavetta per la rimozione della griglia inclusa
Key for grille removal included

Filtro rimovibile
Removable filter

Uscita ø50
Ø50 outlet



Disponibili anche le lunghezze 550 mm e 750 mm
Other length available 550 mm e 750 mm

Dimensioni Size	Portata Water flow			Quantità per conf. Packing Quantity
mm	lpm	Cod. Art./Item Code	€/pz	pz/pcs

SPECIALLINEARG	658x53	200	SPCLA065ILOG	1
ACCIAIO STEEL				

Canaletta/Frame

ABS

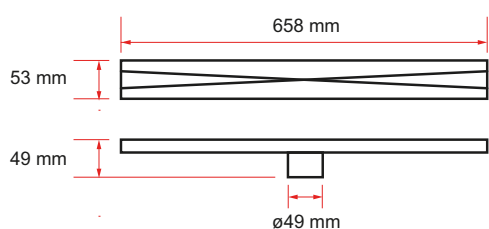

Corpo sifonato/Drain body

ABS

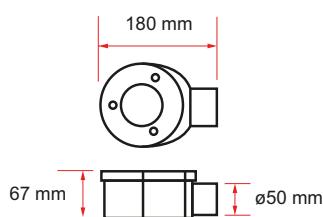

CANALETTA PER DOCCIA CON GRIGLIA INOX
LINEAR SHOWER DRAIN WITH INOX GRATING

Il Kit comprende il corpo sifonato, il foglio di guaina impermeabilizzante con adattatore incorporato, la vaschetta, il filtro e la griglia.

Materiale:

- Vaschetta in PVC
- Corpo sifonato, canaletta e filtro in ABS
- Griglia INOX
- Waterproofing sheet composed of two external layers of polypropylene + an inner layer of polyethylene.

The kit includes the siphon body, the waterproofing sheet with builtin adapter, the drain body, the filter and the grid.

Materiale:

- Drain body, frame adapter and filter in ABS.
- Grid in stainless steel AISI 304.
- Waterproofing sheet composed of two external layers of polypropylene + an inner layer of polyethylene.

Griglia/Grid

INOX

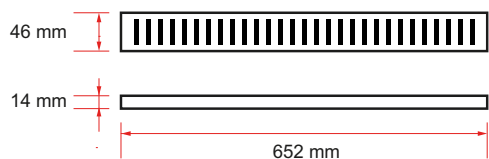

Chiavetta per la rimozione della griglia inclusa
Key for grille removal included

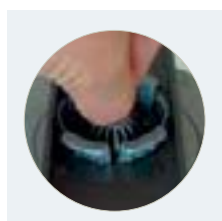

Filtro rimovibile
Removable filter



Uscita ø50
Ø50 outlet

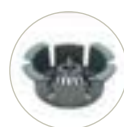

Filtro raccogli capelli
Hair collection filter



Corpo sifonato con guarnizione
Siphoned body with gasket



Griglia
Grid

Canaletta
Frame

Guaina impermeabilizzante
Waterproof sheet

Corpo sifonato
Siphoned body

Disponibili anche le lunghezze 550 mm e 750 mm
Other length available 550 mm e 750 mm

Dimensioni Size	Portata Water flow			Quantità per conf. Packing Quantity
mm	lpm	Cod. Art./Item Code	€/pz	pz/pcs

SPECIALLINEARPG				
ACCIAIO STEEL	656x52	200	SPCL0065ILPG	1

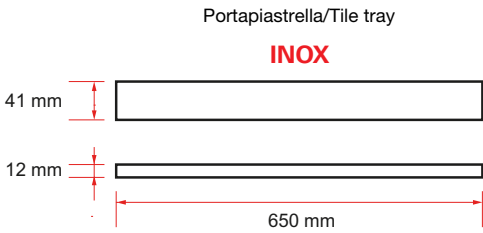
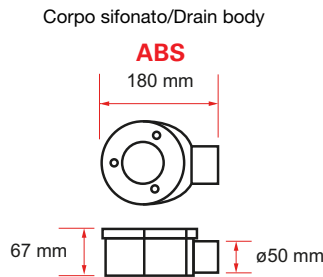
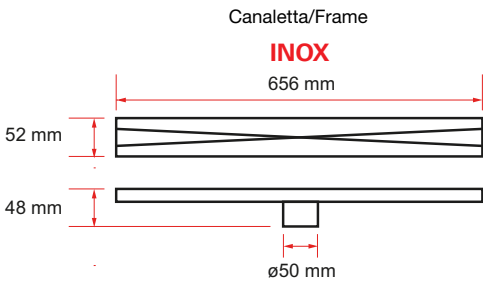

**CANALETTA PER DOCCIA CON PORTAPIASTRELLE INOX
LINEAR SHOWER DRAIN WITH INOX TILE TRAY**

Il Kit comprende il corpo sifonato, il foglio di guaina impermeabilizzante con adattatore incorporato, la vaschetta, il filtro e il portapiastrelle.

Materiale:

- Corpo sifonato e filtro in ABS
- Canaletta e portapiastrella in Acciaio INOX

The kit includes the siphon body, the waterproofing sheet with builtin adapter, the drain body, the filter and the tile tray.

Material:

- Drain body, adapter and filter in ABS.
- Tile tray and body frame in stainless steel AISI 304.
- Waterproofing sheet composed of two external layers of polypropylene + an inner layer of polyethylene.

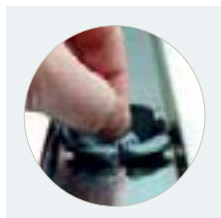

Filtro rimovibile
Removable filter



Uscita ø50
Ø50 outlet

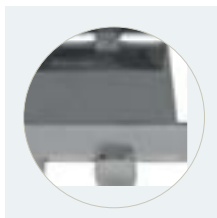

Il porta piastrella è dotato di fermi in gomma
The tile holder is equipped with rubber stops



Disponibili anche le lunghezze 550 mm e 750 mm
Other length available 550 mm e 750 mm

	Dimensioni Size	Portata Water flow			Quantità per conf. Packing Quantity
SPECIALLINEARPG	mm	lpm	Cod. Art./Item Code	€/pz	pz/pcs
ACCIAIO STEEL	658x53	200	SPCLA065ILPG		1

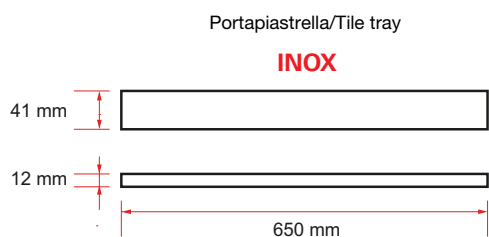
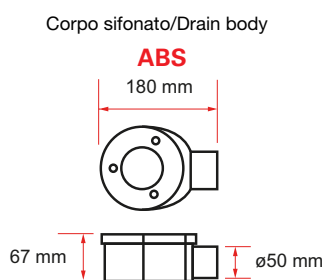
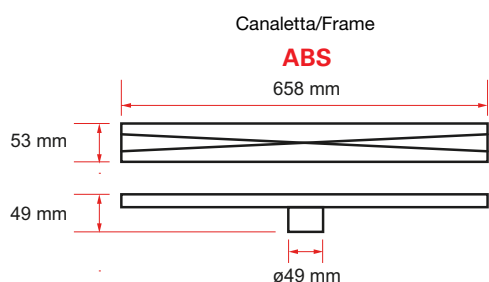

**CANALETTA PER DOCCIA CON PORTAPIASTRELLA INOX
LINEAR SHOWER DRAIN WITH INOX TILE TRAY**

Il Kit comprende il corpo sifonato, il foglio di guaina impermeabilizzante con adattatore incorporato, la vaschetta, il filtro e il portapiastrella.

Materiale:

- Corpo sifonato, canaletta e filtro in ABS
- Portapiastrella in INOX

The kit includes the siphon body, the waterproofing sheet with builtin adapter, the drain body, the filter and the tile tray.

Material:

- Drain body, adapter frame and filter in ABS.
- Tile tray in stainless steel AISI 304.

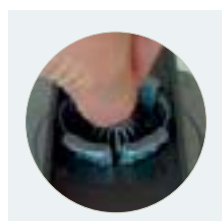

Filtro rimovibile
Removable filter



Uscita ø50
Ø50 outlet

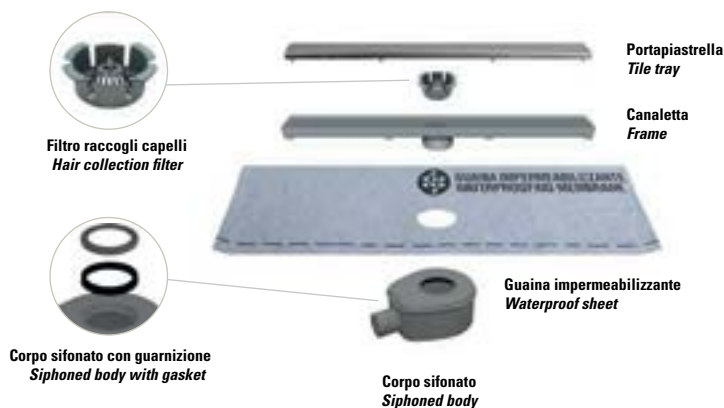

Disponibili anche le lunghezze 550mm e 750mm
Other length available 550mm e 750mm

	Dimensioni <i>Size</i>	Densità <i>Density</i>	m ² x rotolo <i>m² x roll</i>		rotolo <i>roll</i>	Quantità per conf. <i>Packing Quantity</i>
WATERPROOF LAYER	m	g/m ²	m ²	Cod. Art./Item Code	€	pz/pcs
GUAINA SHEATH	1,2x5	300	6	SPMEM5012ROLL		1

MATERIALE:

Guaina composta da due strati di poliolefine EVAC + uno strato di fibra di PP.

MATERIAL:

Membrane composed of two layers of EVAC + a layer of PP fibre.



**Imballo
Packing**





Giunti di Dilatazione, accessori per la posa

Movement joints – Accessories for laying

SPECIALFLEX-PVC	Larghezza Width T	Altezza Height H	Lunghezza Length	Cod. Art./Item Code	PVC grigio/trasparente Grey/transparent PVC		Quantità per conf. Packing Quantity
	mm	mm	m		€/m	€/pz	pz/pcs

PVC PVC

8	8	2	SPFX0808PVG2			50
	10		SPFX1008PVG2			
	12		SPFX1208PVG2			
	14		SPFX1408PVG2			

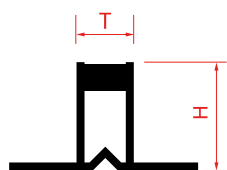

SPECIAL-DCROSS-PVC	Spessore Thickness S	Cod. Art./Item Code	PVC grigio Grey PVC	Quantità per conf. Packing Quantity
	mm		€/busta/bag	pz/pcs

PVC PVC

1	SPDC0001PVG		80 buste da 250 pz 80 bags-250 pcs/bag
2	SPDC0002PVG		
3	SPDC0003PVG		
4	SPDC0004PVG		
5	SPDC0005PVG		
7	SPDC0007PVG		
10	SPDC0010PVG		

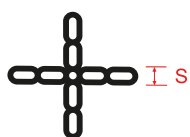

SPECIAL-DTI-PVC	PVC PVC		Cod. Art./Item Code		Quantità per conf. Packing Quantity
3	SPDT0003PVG				
4	SPDT0004PVG				
5	SPDT0005PVG				
7	SPDT0007PVG				
10	SPDT0010PVG				



Giunti di Dilatazione, accessori per la posa

Movement joints – Accessories for laying

	Dimensioni/Size S		PVC nero Black PVC	Quantità per conf. Packing Quantity
SPECIAL-DCU-PVC	mm	Cod. Art./Item Code	€/busta/bag	pz/pcs

PVC PVC

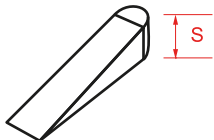

0-5	SPDU0005PVG		40 buste da 500 pz 40 bag-500 pcs/bag
0-10	SPDU0010PVG		16 buste da 500 pz 16 bag-500 pcs/bag

Distanziatori autolivellanti

Self leveling spacers

	Dimensioni/Size S		PVC nero Black PVC	Quantità per conf. Packing Quantity
SPECIAL-DCUX-PVC	mm	Cod. Art./Item Code	€/busta/bag	pz/pcs

PVC PVC

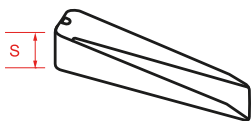

22	SPDU0022PVG		4 buste da 250 pz 4 bag-250 pcs/bag
----	-------------	--	--

Altezza mattonelle Tiles height	Dimensioni Size S	Colore Colours		PVC nero Black PVC	Quantità per conf. Packing Quantity
SPECIAL-TC-PVC	mm	mm	Cod. Art./Item Code	€/busta/bag	pz/pcs

PVC PVC

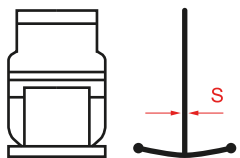

3-12	0,5	verde/green	SPDR0005PVG	10 buste da 250 pz 10 bag-250 pcs/bag
3-12	1	grigio/grey	SPDR0001PVG	
3-12	1,5	blu/bleu	SPDR0015PVG	
3-12	2	bianco/white	SPDR0002PVG	
3-12	3	giallo/yellow	SPDR0003PVG	
10-20	2	arancio/orange	SPDR0020PVG	8 buste da 250 pz 8 bag-250 pcs/bag

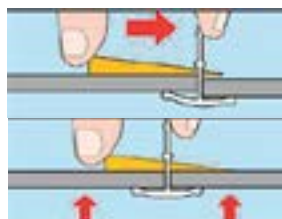



SPECIAL
PROFILES

Profili in Alluminio per il Fai da Te

Aluminium Do It Yourself Profiles



PIATTO FLAT BAR	Spessore Thickness T	Dimensioni Size W	Lunghezza Length	completa il cod. art. (xxx) con il tipo di finitura complete item code (xxx) with the finish type	Anodizzato Argento Silver Anodized			Verniciato bianco White painted	Quantità per conf. Packing quantity
					Naturale Natural	Satinato Silver	Brillante Bright silver		
					(ANA)	(AAA)	(ABA)		
mm	mm	m	Cod. Art./Item Code	€/pz	€/pz	€/pz	€/pz	pz/pcs	

ALLUMINIO ALUMINIUM

2	10	1	SPPI1002xxx01					10
		2	SPPI1002xxx02					
		3	SPPI1002xxx03					
	12	1	SPPI1202xxx01					
		2	SPPI1202xxx02					
		3	SPPI1202xxx03					
	15	1	SPPI1502xxx01					
		2	SPPI1502xxx02					
		3	SPPI1502xxx03					
	20	1	SPPI2002xxx01					
		2	SPPI2002xxx02					
		3	SPPI2002xxx03					
	25	1	SPPI2502xxx01					
		2	SPPI2502xxx02					
		3	SPPI2502xxx03					
	30	1	SPPI3002xxx01					
		2	SPPI3002xxx02					
		3	SPPI3002xxx03					
	35	1	SPPI3502xxx01					
		2	SPPI3502xxx02					
		3	SPPI3502xxx03					
	40	1	SPPI4002xxx01					
		2	SPPI4002xxx02					
		3	SPPI4002xxx03					
50	1	SPPI5002xxx01						
	2	SPPI5002xxx02						
	3	SPPI5002xxx03						



ANGOLARE ANGLE, EQUAL SIDED	Spessore Thickness T	Dimensioni Size W	Lunghezza Length	completa il cod. art. (xxx) con il tipo di finitura complete item code (xxx) with the finish type	Anodizzato Argento Silver Anodized			Verniciato Bianco White painted (AVB)	Quantità per conf. Packing Quantity
					Naturale Natural	Satinato Silver	Brillante Bright silver		
					(ANA)	(AAA)	(ABA)		
	mm	mm	m	Cod. Art./Item Code	€/pz	€/pz	€/pz	€/pz	pz/pcs

ALLUMINIO ALUMINIUM

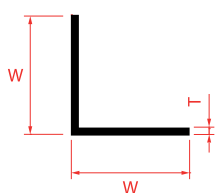

1	10	1	SPAN1010xxx01					10
		2	SPAN1010xxx02					
		3	SPAN1010xxx03					
	15	1	SPAN1515xxx01					
		2	SPAN1515xxx02					
		3	SPAN1515xxx03					
	20	1	SPAN2020xxx01					
		2	SPAN2020xxx02					
		3	SPAN2020xxx03					
	25	1	SPAN2525xxx01					
		2	SPAN2525xxx02					
		3	SPAN2525xxx03					
	30	1	SPAN3030xxx01					
		2	SPAN3030xxx02					
		3	SPAN3030xxx03					
1,5	40	1	SPAN4040xxx01					
		2	SPAN4040xxx02					
		3	SPAN4040xxx03					
	50	1	SPAN5050xxx01					
		2	SPAN5050xxx02					
		3	SPAN5050xxx03					

ELLE L PROFILE	Spessore Thickness T	Dimensioni Size WxH	Lunghezza Length	completa il cod. art. (xxx) con il tipo di finitura complete item code (xxx) with the finish type	Anodizzato Argento Silver Anodized			Verniciato Bianco White painted (AVB)	Quantità per conf. Packing Quantity
					Naturale Natural	Satinato Silver	Brillante Bright silver		
					(ANA)	(AAA)	(ABA)		
mm	mm	m	Cod. Art./Item Code	€/pz	€/pz	€/pz	€/pz	pz/pcs	

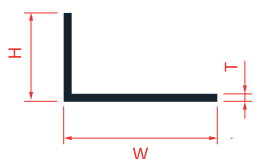
ALLUMINIO ALUMINIUM

1	15x10	1	SPEL1510xxx01					10
		2	SPEL1510xxx02					
		3	SPEL1510xxx03					
	20x10	1	SPEL2010xxx01					
		2	SPEL2010xxx02					
		3	SPEL2010xxx03					
	25x15	1	SPEL2515xxx01					
		2	SPEL2515xxx02					
		3	SPEL2515xxx03					
	30x15	1	SPEL3015xxx01					
		2	SPEL3015xxx02					
		3	SPEL3015xxx03					
	30x20	1	SPEL3020xxx01					
		2	SPEL3020xxx02					
		3	SPEL3020xxx03					
	40x10	1	SPEL4010xxx01					
		2	SPEL4010xxx02					
		3	SPEL4010xxx03					
	40x15	1	SPEL4015xxx01					
		2	SPEL4015xxx02					
		3	SPEL4015xxx03					



"U" U PROFILE	Spessore Thickness T mm	Dimensioni Size WxH mm	Lunghezza Length m	completa il cod. art. (xxx) con il tipo di finitura complete item code (xxx) with the finish type Cod. Art./Item Code	Anodizzato Argento Silver Anodized			Verniciato Bianco White painted (AVB)	Quantità per conf. Packing Quantity pz/pcs
					Naturale Natural (ANA)	Satinato Silver (AAA)	Brillante Bright silver (ABA)		
					€/pz	€/pz	€/pz		

ALLUMINIO ALUMINIUM

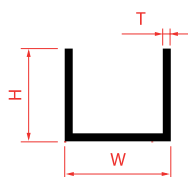

1	8x8	1	SPCU0808xxx01					10
		2	SPCU0808xxx02					
		3	SPCU0808xxx03					
	10x10	1	SPCU1010xxx01					
		2	SPCU1010xxx02					
		3	SPCU1010xxx03					
	10x15	1	SPCU1015xxx01					
		2	SPCU1015xxx02					
		3	SPCU1015xxx03					
	15x10	1	SPCU1510xxx01					
		2	SPCU1510xxx02					
		3	SPCU1510xxx03					
	15x15	1	SPCU1515xxx01					
		2	SPCU1515xxx02					
		3	SPCU1515xxx03					
	20x20	1	SPCU2020xxx01					
		2	SPCU2020xxx02					
		3	SPCU2020xxx03					

DOPPIA "U" UU PROFILE	Spessore Thickness T	Dimensioni Size WxH	Lunghezza Length L	completa il cod. art. (xxx) con il tipo di finitura complete item code (xxx) with the finish type	Anodizzato Argento Silver Anodized			Verniciato Bianco White painted (AVB)	Quantità per conf. Packing Quantity
					Naturale Natural	Satinato Silver	Brillante Bright silver		
					(ANA)	(AAA)	(ABA)		
mm	mm	m	Cod. Art./Item Code	€/pz	€/pz	€/pz	€/pz	pz/pcs	

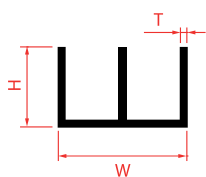
ALLUMINIO ALUMINIUM

1	16x7	1	SPUU1607xxx01					10
		2	SPUU1607xxx02					
		3	SPUU1607xxx03					
	16x12	1	SPUU1612xxx01					
		2	SPUU1612xxx02					
		3	SPUU1612xxx03					
	20x10	1	SPUU2010xxx01					
		2	SPUU2010xxx02					
		3	SPUU2010xxx03					
	20x18	1	SPUU2018xxx01					
		2	SPUU2018xxx02					
		3	SPUU2018xxx03					

Dimensioni Size D
mm

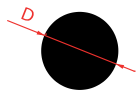
**TONDO PIENO
ROUND BAR**
ALLUMINIO ALUMINIUM

6	6	1	SPTP0006xxx01					10
		2	SPTP0006xxx02					
		3	SPTP0006xxx03					
	8	1	SPTP0008xxx01					
		2	SPTP0008xxx02					
		3	SPTP0008xxx03					
	10	1	SPTP0010xxx01					
		2	SPTP0010xxx02					
		3	SPTP0010xxx03					
	12	1	SPTP0012xxx01					
		2	SPTP0012xxx02					
		3	SPTP0012xxx03					



TUBO TONDO ROUND TUBE	Spessore Thickness T	Dimensioni Size D	Lunghezza Length L	completa il cod. art. (xxx) con il tipo di finitura complete item code (xxx) with the finish type	Anodizzato Argento Silver Anodized			Verniciato Bianco White painted (AVB)	Quantità per conf. Packing Quantity
					Naturale Natural	Satinato Silver	Brillante Bright silver		
					(ANA)	(AAA)	(ABA)		
mm	mm	m	Cod. Art./Item Code	€/pz	€/pz	€/pz	€/pz	pz/pcs	

ALLUMINIO ALUMINIUM

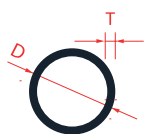

1	6	1	SPTT0601xxx01					10
		2	SPTT0601xxx02					
		3	SPTT0601xxx03					
	8	1	SPTT0801xxx01					
		2	SPTT0801xxx02					
		3	SPTT0801xxx03					
	10	1	SPTT1001xxx01					
		2	SPTT1001xxx02					
		3	SPTT1001xxx03					
	12	1	SPTT1201xxx01					
		2	SPTT1201xxx02					
		3	SPTT1201xxx03					
	16	1	SPTT1601xxx01					
		2	SPTT1601xxx02					
		3	SPTT1601xxx03					
	18	1	SPTT1801xxx01					
		2	SPTT1801xxx02					
		3	SPTT1801xxx03					
	20	1	SPTT2001xxx01					
		2	SPTT2001xxx02					
		3	SPTT2001xxx03					
	24	1	SPTT2401xxx01					
		2	SPTT2401xxx02					
		3	SPTT2401xxx03					

Completare il Cod. Art. con il tipo di finitura: es. Alluminio Naturale (**ANA**) -> SPPI0802**ANA**01
Complete item code with the finish type: e.g. for Natural Aluminium (**ANA**) -> SPPI0802**ANA**01

TUBO QUADRO SQUARE TUBE	Spessore Thickness T	Dimensioni Size WxH	Lunghezza Length	completa il cod. art. (xxx) con il tipo di finitura complete item code (xxx) with the finish type	Anodizzato Argento Silver Anodized			Verniciato Bianco White painted (AVB)	Quantità per conf. Packing Quantity
					Naturale Natural	Satinato Silver	Brillante Bright silver		
					(ANA)	(AAA)	(ABA)		
mm	mm	m	Cod. Art./Item Code	€/pz	€/pz	€/pz	€/pz	pz/pcs	

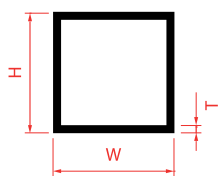
ALLUMINIO ALUMINIUM

1	10x10	1	SPTQ1010xxx01					10
		2	SPTQ1010xxx02					
		3	SPTQ1010xxx03					
	15x15	1	SPTQ1515xxx01					
		2	SPTQ1515xxx02					
		3	SPTQ1515xxx03					
	20x20	1	SPTQ2020xxx01					
		2	SPTQ2020xxx02					
		3	SPTQ2020xxx03					

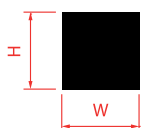
**QUADRO PIENO
SQUARE BAR**
ALLUMINIO ALUMINIUM

1	8x8	1	SPQP0808xxx01					10
		2	SPQP0808xxx02					
		3	SPQP0808xxx03					
	10x10	1	SPQP1010xxx01					
		2	SPQP1010xxx02					
		3	SPQP1010xxx03					

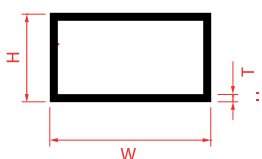
**TUBO RETTANGOLARE
RECTANGULAR TUBE**
ALLUMINIO ALUMINIUM

1	20x10	1	SPTR2010xxx01					10
		2	SPTR2010xxx02					
		3	SPTR2010xxx03					
	30x15	1	SPTR3015xxx01					
		2	SPTR3015xxx02					
		3	SPTR3015xxx03					

Completare il Cod. Art. con il tipo di finitura: es. Alluminio Naturale (**ANA**) -> SPPI0802**ANA**01
Complete item code with the finish type: e.g. for Natural Aluminium (**ANA**) -> SPPI0802**ANA**01

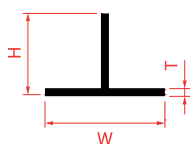

"T" T PROFILE	Spessore Thickness T	Dimensioni Size WxH	Lunghezza Length	completa il cod. art. (xxx) con il tipo di finitura complete item code (xxx) with the finish type	Anodizzato Argento Silver Anodized			Verniciato Bianco White painted (AVB)	Quantità per conf. Packing Quantity
					Naturale Natural	Satinato Silver	Brillante Bright silver		
					(ANA)	(AAA)	(ABA)		
mm	mm	m	Cod. Art./Item Code	€/pz	€/pz	€/pz	€/pz	pz/pcs	

ALLUMINIO ALUMINIUM

1,5	15x15	1	SPPT1515xxx01					10
		2	SPPT1515xxx02					
		3	SPPT1515xxx03					
	20x20	1	SPPT2020xxx01					
		2	SPPT2020xxx02					
		3	SPPT2020xxx03					
	25x25	1	SPPT2525xxx01					
		2	SPPT2525xxx02					
		3	SPPT2525xxx03					
	30x15	1	SPPT3015xxx01					
		2	SPPT3015xxx02					
		3	SPPT3015xxx03					



SPECIAL
PROFILES

Profili in Acciaio per il Fai da Te
Steel Do It Yourself Profiles



PIATTO FLAT BAR	Spessore Thickness T	Dimensioni Size W	completa il cod. art. (xx) con il tipo di lunghezza complete item code (xx) with the length	Finitura/Finishing: Acciaio Lucido/Polished Steel		Quantità per conf. Packing Quantity
				Lunghezza Length		
				(1 m)	(2 m)	
mm	mm	Cod. Art./Item Code	€/pz	€/pz	pz/pcs	

ACCIAIO STEEL

0,7	10	SPPI1007ILAxx			10
0,25		SPPI1002ILAxx			
0,7	15	SPPI1507ILAxx			
0,25		SPPI1502ILAxx			
0,7	20	SPPI2007ILAxx			
0,25		SPPI2002ILAxx			
0,7	25	SPPI2507ILAxx			
0,25		SPPI2502ILAxx			
0,7	30	SPPI3007ILAxx			
0,25		SPPI3002ILAxx			
0,7	40	SPPI4007ILAxx			
0,25		SPPI4002ILAxx			
0,7	50	SPPI5007ILAxx			
0,25		SPPI5002ILAxx			

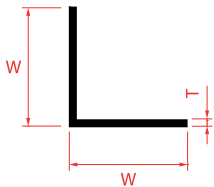
**ANGOLARE
ANGLE, EQUAL SIDED**
ACCIAIO STEEL

0,7	10	SPAN1007ILAxx			10
0,25		SPAN1002ILAxx			
0,7	15	SPAN1507ILAxx			
0,25		SPAN1502ILAxx			
0,7	20	SPAN2007ILAxx			
0,25		SPAN2002ILAxx			
0,7	30	SPAN3007ILAxx			
0,25		SPAN3002ILAxx			
0,7	40	SPAN4007ILAxx			
0,25		SPAN4002ILAxx			
0,7	50	SPAN5007ILAxx			
0,25		SPAN5002ILAxx			

lunghezze superiori a 2 m disponibili solo su richiesta - lunghezza massima fornibile m 2.7.
 lengths longer than 2 m available on request only - maximum length available 2.7 m.

Completare il Cod. Art. con la lunghezza barra: ad es.barra da 1 metro -> SPPI1007IL01 (01 = 1m) (02 = 2m)
 Complete item code with the bar's length: e.g. for 1 m -> SPPI1007IL01 (01 = 1m) (02 = 2m)



Spessore Thickness T	Dimensioni Size WxH	completa il cod. art. (xx) con il tipo di lunghezza <i>complete item code (xx) with the length</i>	Finitura/Finishing: Acciaio Lucido/Polished Steel		Quantità per conf. <i>Packing Quantity</i>
			Lunghezza Length		
			(1 m)	(2 m)	
mm	mm	Cod. Art./Item Code	€/pz	€/pz	pz/pcs

ELLE
L PROFILE

ACCIAIO STEEL

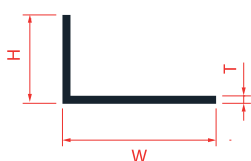

0,7	15x10	SPEL151007ILAxx			10
0,25		SPEL151002ILAxx			
0,7	20x10	SPEL201007ILAxx			
0,25		SPEL201002ILAxx			
0,7	30x20	SPEL302007ILAxx			
0,25		SPEL302002ILAxx			
0,7	40x10	SPEL401007ILAxx			
0,25		SPEL401002ILAxx			



"U"

U PROFILE

ACCIAIO STEEL

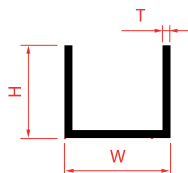

0,7	10x10	SPCU101007ILAxx			10
0,25		SPCU101002ILAxx			
0,7	10x15	SPCU101507ILAxx			
0,25		SPCU101502ILAxx			
0,7	10x20	SPCU102007ILAxx			
0,25		SPCU102002ILAxx			
0,7	15x10	SPCU151007ILAxx			
0,25		SPCU151002ILAxx			
0,7	15x15	SPCU151507ILAxx			
0,25		SPCU151502ILAxx			
0,7	20x20	SPCU202007ILAxx			
0,25		SPCU202002ILAxx			



lunghezze superiori a 2 m disponibili solo su richiesta - lunghezza massima fornibile m 2.7.
lengths longer than 2 m available on request only - maximum length available 2.7 m.

Completare il Cod. Art. con la lunghezza barra: ad es.barra da 1 metro -> SPPI1007IL01 (01 = 1m) (02 = 2m)
Complete item code with the bar's length: e.g. for 1 m -> SPPI1007IL01 (01 = 1m) (02 = 2m)



SPECIAL
PROFILES

Profili in Ferro Naturale per il Fai da Te

Do It Yourself Iron profiles

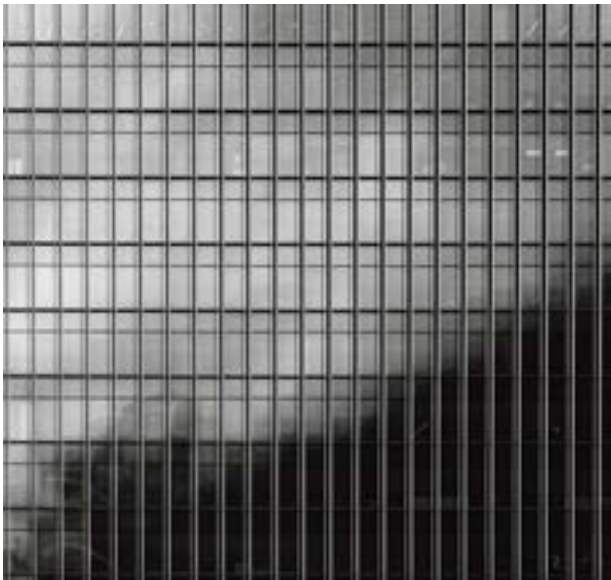

PIATTO FLAT BAR	Spessore Thickness T	Dimensioni Size W	completa il cod. art. (xx) con il tipo di lunghezza complete item code (xx) with the length	Lunghezza Length			Quantità per conf. Packing Quantity
				(1 m)	(2 m)	(3 m)	
	mm	mm	Cod. Art./Item Code	€/pz	€/pz	€/pz	pz/pcs

FERRO IRON

3	15	SPPI1503FNxx				6
	20	SPPI2003FNxx				
	25	SPPI2503FNxx				
	30	SPPI3003FNxx				
4	40	SPPI4004FNxx				
5	50	SPPI5005FNxx				

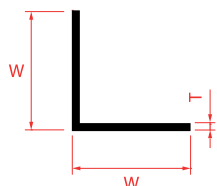
**ANGOLARE
ANGLE, EQUAL SIDED**
FERRO IRON

3	15	SPAN1515FNxx				6
	20	SPAN2020FNxx				
	25	SPAN2525FNxx				
	30	SPAN3030FNxx				
	40	SPAN4040FNxx				

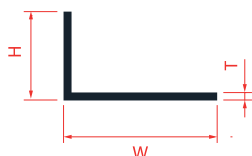
**ELLE
L PROFILE**
FERRO IRON

ELLE L PROFILE	Spessore Thickness T	Dimensioni Size WxH	completa il cod. art. (xx) con il tipo di lunghezza complete item code (xx) with the length	Lunghezza Length			Quantità per conf. Packing Quantity
				(1 m)	(2 m)	(3 m)	
	mm	mm	Cod. Art./Item Code	€/pz	€/pz	€/pz	pz/pcs
4	30x20	SPEL3020FNxx				6	
	40x20	SPEL4020FNxx					

Completare il Cod. Art. con la lunghezza barra: ad es. barra da 1 metro -> SPPI1007IL01 (01 = 1m) (02 = 2m) (03 = 3m)
 Complete item code with the bar's length: e.g. for 1 m -> SPPI1007IL01 (01 = 1m) (02 = 2m) (03 = 3m)

"U" U PROFILE	Spessore Thickness T	Dimensioni Size WxH	completa il cod. art. (xx) con il tipo di lunghezza complete item code (xx) with the length	Lunghezza Length			Quantità per conf. Packing Quantity
				(1 m)	(2 m)	(3 m)	
				€/pz	€/pz	€/pz	
	mm	mm	Cod. Art./Item Code				pz/pcs

FERRO IRON

1,5	15x15	SPCU1515FNxx				6
	30x20	SPCU3020FNxx				

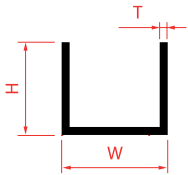

Dimensioni Size D
mm

**TONDO PIENO
ROUND BAR**
FERRO IRON

	6	SPTP0006FNxx				6
	8	SPTP0008FNxx				
	10	SPTP0010FNxx				
	12	SPTP0012FNxx				
	16	SPTP0016FNxx				

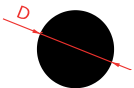
**TUBO TONDO
ROUND TUBE**
FERRO IRON

1	12	SPTT1201FNxx				6
	16	SPTT1601FNxx				
1,2	20	SPTT2001FNxx				
	25	SPTT2501FNxx				
1,5	30	SPTT3001FNxx				
	40	SPTT4001FNxx				

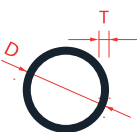

TUBO OVALE OVAL TUBE	Spessore Thickness T	Dimensioni Size WxH	completa il cod. art. (xx) con il tipo di lunghezza complete item code (xx) with the length	Lunghezza Length			Quantità per conf. Packing Quantity
				(1 m)	(2 m)	(3 m)	
				mm	mm	Cod. Art./Item Code	

FERRO IRON

1,5	20x10	SPTO2010FNxx				6
	30x15	SPTO3015FNxx				

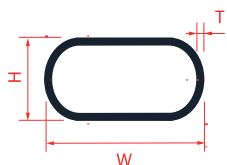

TUBO QUADRO SQUARE TUBE	FERRO IRON	1,5	12x12	SPTQ1212FNxx				6
			15x15	SPTQ1515FNxx				
			20x20	SPTQ2020FNxx				
	25x25	SPTQ2525FNxx						
	30x30	SPTQ3030FNxx						
	40x40	SPTQ4040FNxx						

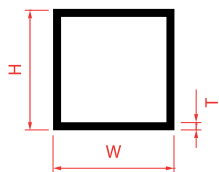

QUADRO PIENO SQUARE BAR	FERRO IRON	1,5	8x8	SPQP0808FNxx				6
			10x10	SPQP1010FNxx				
			12x12	SPQP1212FNxx				
	14x14	SPQP1414FNxx						

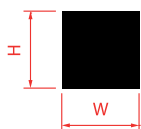

Completare il Cod. Art. con la lunghezza barra: ad es. barra da 1 metro -> SPPI1007IL01 (01 = 1m) (02 = 2m) (03 = 3m)
Complete item code with the bar's length: e.g. for 1 m -> SPPI1007IL01 (01 = 1m) (02 = 2m) (03 = 3m)



TUBO RETTANGOLARE RECTANGULAR TUBE	Spessore Thickness T	Dimensioni Size WxH	completa il cod. art. (xx) con il tipo di lunghezza complete item code (xx) with the length	Lunghezza Length			Quantità per conf. Packing Quantity
				(1 m)	(2 m)	(3 m)	
	mm	mm	Cod. Art./Item Code	€/pz	€/pz	€/pz	pz/pcs

FERRO IRON

1,5	30x20	SPTR3020FNxx				6
	40x20	SPTR4020FNxx				

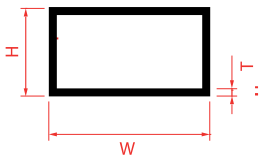

"T" T PROFILE	4	20x20	SPPT2020FNxx				6
			25x25	SPPT2525FNxx			
FERRO IRON	5	30x30	SPPT3030FNxx				

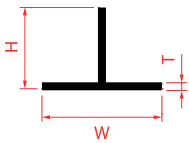



SPECIAL
PROFILES

Lamiere e Profili in Alluminio, Acciaio per il Fai da te
Aluminium, Iron, Steel sheets and Profiles for Do It Yourself



ANGOLARE ANGLE, EQUAL SIDE	Spessore Thickness T	Dimensioni Size WxH	completa il cod. art. (xx) con il tipo di lunghezza complete item code (xx) with the length	Lunghezza Length		Quantità per conf. Packing Quantity
				(1 m)	(2 m)	
				€/pz	€/pz	

ALLUMINIO ALUMINIUM

1,5	20x20	SPAN2020ANCxx			10
	25x25	SPAN2525ANCxx			
	30x30	SPAN3030ANCxx			
	40x40	SPAN4040ANCxx			

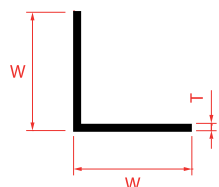

ELLE L PROFILE	1,5	40x20	SPEL4020ANCxx			10
		50x30	SPEL5030ANCxx			

ALLUMINIO ALUMINIUM

"U" U PROFILE	1,5	22,5x22,5	SPCU2222ANCxx			10
		25,5x25,5 <td>SPCU2525ANCxx</td> <td></td> <td></td>	SPCU2525ANCxx			

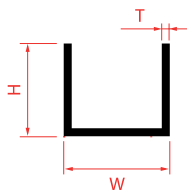
ALLUMINIO ALUMINIUM

lunghezze superiori a 2 m disponibili solo su richiesta - lunghezza massima fornibile m 2.7.
lengths longer than 2 m available on request only - maximum length available 2.7 m.

Completare il Cod. Art. con la lunghezza barra: ad es.barra da 1 metro -> SPP1007IL01 (01 = 1m) (02 = 2m)
Complete item code with the bar's length: e.g. for 1 m -> SPP1007IL01 (01 = 1m) (02 = 2m)



LAMIERE SHEET METAL	Spessore Thickness T	Dimensioni Size W	Dimensioni Size H			Quantità per conf. Packing Quantity
	mm	mm	mm	Cod. Art./Item Code	€/pz	pz/pcs

ALLUMINIO LISCIO
NATURALE
NATURAL ALUMINIUM
SHEETALUMINIUM

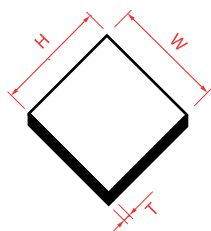

0,7 0,25 0,7 0,25 0,7 0,25 0,7 0,25 0,7 0,25	500	200	SPLA5020AN07		10
			SPLA5020AN02		
		400	SPLA5040AN07		
			SPLA5040AN02		
		500	SPLA5050AN07		
			SPLA5050AN02		
	600	SPLA5060AN07			
		SPLA5060AN02			
	1000	SPLA5010AN07			
		SPLA5010AN02			

0,7 0,25 0,7 0,25 0,7 0,25 0,7 0,25 0,7 0,25	600	200	SPLA6020AN07		10
			SPLA6020AN02		
		400	SPLA6040AN07		
			SPLA6040AN02		
		500	SPLA6050AN07		
			SPLA6050AN02		
	600	SPLA6060AN07			
		SPLA6060AN02			
	1000	SPLA6010AN07			
		SPLA6010AN02			

LAMIERE
SHEET METAL

ALLUMINIO LISCIO
ANODIZZATO SATINATO
SILVER ANODIZED
ALUMINIUM SHEET

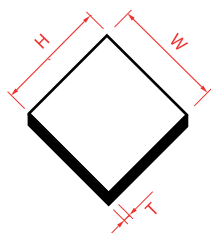

0,7 0,25 0,7 0,25 0,7 0,25 0,7 0,25 0,7 0,25	500	200	SPLA5020AAA07		10
			SPLA5020AAA02		
		400	SPLA5040AAA07		
			SPLA5040AAA02		
		500	SPLA5050AAA07		
			SPLA5050AAA02		
	600	SPLA5060AAA07			
		SPLA5060AAA02			
	1000	SPLA5010AAA07			
		SPLA5010AAA02			

0,7 0,25 0,7 0,25 0,7 0,25 0,7 0,25 0,7 0,25	600	200	SPLA6020AAA07		10
			SPLA6020AAA02		
		400	SPLA6040AAA07		
			SPLA6040AAA02		
		500	SPLA6050AAA07		
			SPLA6050AAA02		
	600	SPLA6060AAA07			
		SPLA6060AAA02			
	1000	SPLA6010AAA07			
		SPLA6010AAA02			

LAMIERE SHEET METAL	Spessore Thickness T	Dimensioni Size W	Dimensioni Size H			Quantità per conf. Packing Quantity
	mm	mm	mm	Cod. Art./Item Code	€/pz	pz/pcs

**ALLUMINIO LISCIO
BRILLANTE**
*BRIGHT SILVER ANODIZED
ALUMINIUM SHEET*

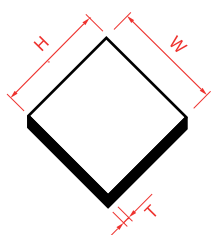

500	0,7	200	SPLA5020ABA07		10
	0,25		SPLA5020ABA02		
	0,7	400	SPLA5040ABA07		
	0,25		SPLA5040ABA02		
	0,7	500	SPLA5050ABA07		
	0,25		SPLA5050ABA02		
	0,7	600	SPLA5060ABA07		
	0,25		SPLA5060ABA02		
	0,7	1000	SPLA5010ABA07		
	0,25		SPLA5010ABA02		

600	0,7	200	SPLA6020ABA07		10
	0,25		SPLA6020ABA02		
	0,7	400	SPLA6040ABA07		
	0,25		SPLA6040ABA02		
	0,7	500	SPLA6050ABA07		
	0,25		SPLA6050ABA02		
	0,7	600	SPLA6060ABA07		
	0,25		SPLA6060ABA02		
	0,7	1000	SPLA6010ABA07		
	0,25		SPLA6010ABA02		



LAMIERE SHEET METAL	Spessore Thickness T	Dimensioni Size W	Dimensioni Size H			Quantità per conf. Packing Quantity
	mm	mm	mm	Cod. Art./Item Code	€/pz	pz/pcs
ALLUMINIO CHICCO DI RISO NATURALE <i>RICE GRAIN NATURAL ALUMINIUM SHEET</i>	1,5	500	200	SPLC5020ANC02		10
			500	SPLC5050ANC02		
			600	SPLC5060ANC02		
		600	200	SPLC6020ANC02		
			600	SPLC6060ANC02		
			1000	SPLC6010ANC02		

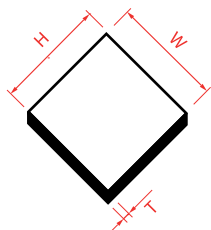

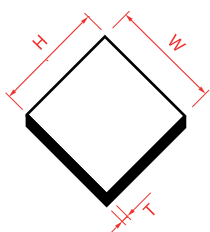

LAMIERE SHEET METAL	Spessore Thickness T	Dimensioni Size W	Dimensioni Size H			Quantità per conf. Packing Quantity
	mm	mm	mm	Cod. Art./Item Code	€/pz	pz/pcs

**ACCIAIO LISCIO
BRILLANTE
BRIGHT STEEL
SHEET**

500	0,7	200	SPLA5020IL07		10
	0,25		SPLA5020IL02		
	0,7	400	SPLA5040IL07		
	0,25		SPLA5040IL02		
	0,7	500	SPLA5050IL07		
	0,25		SPLA5050IL02		
	0,7	600	SPLA5060IL07		
	0,25		SPLA5060IL02		
	0,7	1000	SPLA5010IL07		
	0,25		SPLA5010IL02		

600	0,7	200	SPLA6020IL07		10
	0,25		SPLA6020IL02		
	0,7	400	SPLA6040IL07		
	0,25		SPLA6040IL02		
	0,7	500	SPLA6050IL07		
	0,25		SPLA6050IL02		
	0,7	600	SPLA6060IL07		
	0,25		SPLA6060IL02		
	0,7	1000	SPLA6010IL07		
	0,25		SPLA6010IL02		

LAMIERE STIRATE STRETCHED SHEETS	Spessore Thickness T	Dimensioni Size W	Dimensioni Size H		Ferro zincato Galvanized iron	Alluminio Naturale Natural aluminium	Acciaio Stainless steel	Quantità per conf. Packing Quantity
	mm	mm	mm	Cod. Art./Item Code	€/pz	€/pz	€/pz	pz/pcs

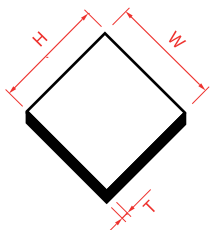

0,8	400	500	SPLS4050FZ08				10
			SPLS4050AN08				
			SPLS4050IL08				
		1000	SPLS4010FZ08				
			SPLS4010AN08				
			SPLS4010IL08				
	600	500	SPLS6050FZ08				
			SPLS6050AN08				
			SPLS6050IL08				
		1000	SPLS6010FZ08				
			SPLS6010AN08				
			SPLS6010IL08				

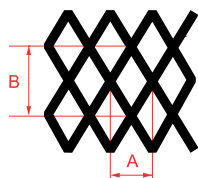
 AxB 6x10 Alluminio/Aluminium
 AxB 8x16 Acciaio/Steel



SPECIAL
PROFILES

Sistemi espositivi e proposte di Vendita

Display systems and sales proposals



Special Profiles

Tutti gli espositori Special Profiles sono studiati per offrire la massima visibilità dei prodotti e nel contempo ridurre al minimo gli ingombri. Anche la funzionalità è quanto di meglio si possa trovare sul mercato, per la semplicità con cui i vari profili si possono estrarre e reinserire. Spazi predefiniti e guidati, sia meccanicamente che tramite icone, permettono di avere tutti gli espositori facilmente e sempre in ordine. Abbondanti esempi di utilizzo facilitano la perfetta comprensione del contenuto. Tutti gli espositori sono modulari, potendo creare in maniera flessibile la propria esposizione, in funzione delle varie esigenze e disponibilità di spazio.

Infine grazie al loro design è possibile collocarli anche in ambienti spiccatamente eleganti, come una show room, impreziosendo l'ambiente.

Special Profiles

All Special Profiles displays are designed to offer maximum product visibility and at the same time reduce the overall dimensions. Functionality is also the best you can find on the market, for the simplicity with which the various profiles can be extracted and reinserted. Predefined and guided spaces, both mechanically and through icons, allow all displays to be easily and always in order. Many examples of use facilitate the perfect understanding of the content. All display units are modular, being able to flexibly create their own area, according to the various needs and space availability.

Finally, thanks to their design, they can also be placed in distinctly elegant environments, such as a show room, enhancing the environment.

FAI DA TE / DIY

BIG 2

BIG 3

BIG 4

SMALL 2

PROFILI/PROFILES

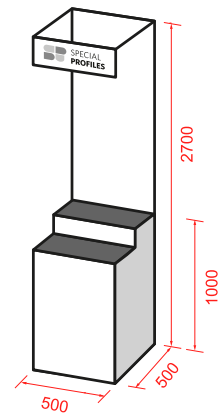
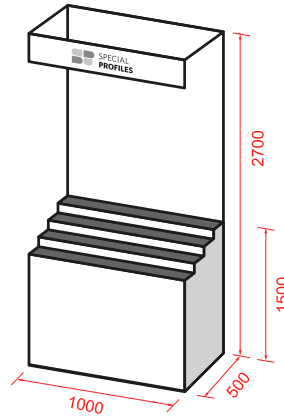
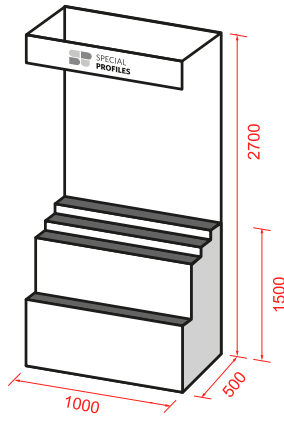
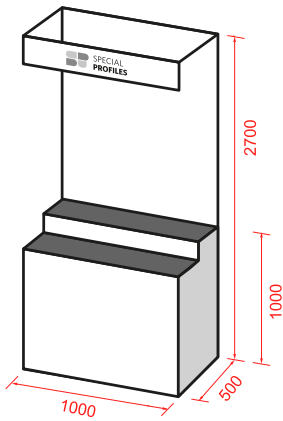

BIG SLOT

SMALL SLOT

BIG FRAME

SMALL FRAME

LAMIERE/SHEETS

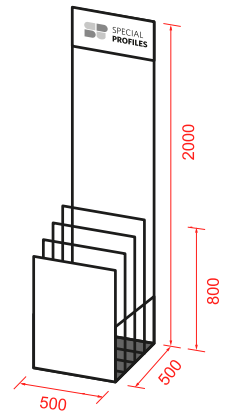
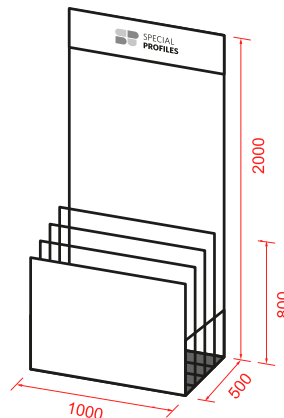
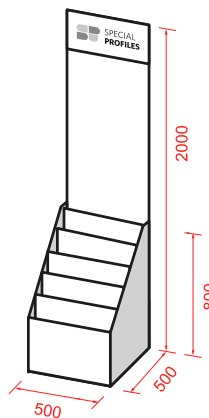
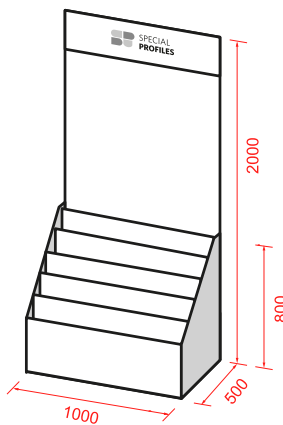

CERAMICA, EDILIZIA / TILES, BUILDING SYSTEMS

BIG TILE

SMALL TILE

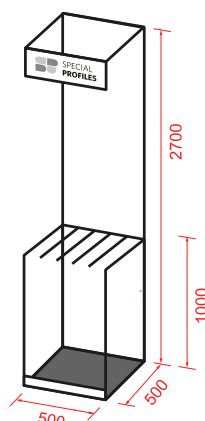
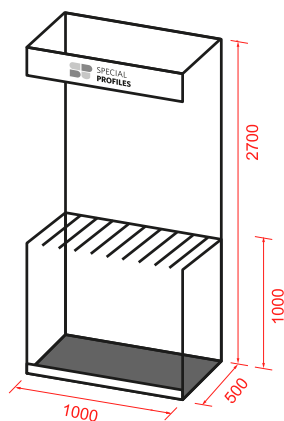

PROPOSTA FAI DA TE ALLUMINIO ALUMINIUM DIY PROPOSALS

BIG 2

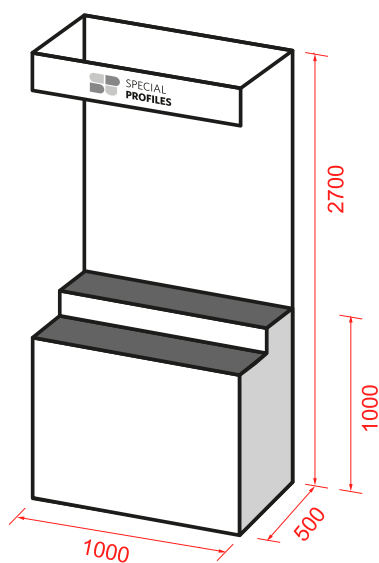



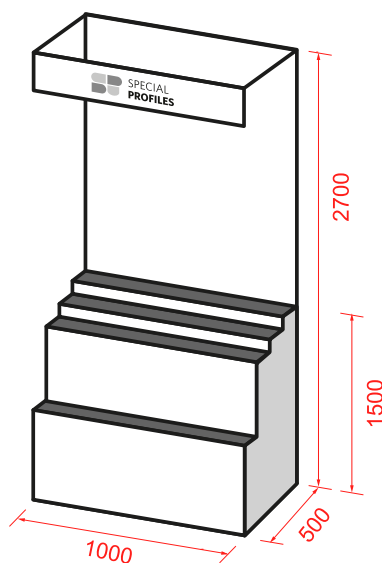



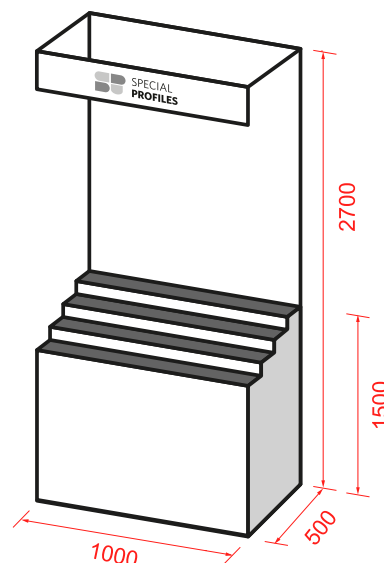



BIG 3



BIG 4



	pz / tipo pcs / type	Tot. referenze Total of references	Tot. barre Total of bars	Codice proposta Barre 2 mt Proposal code 2 m Bars	Prezzo Price €	Codice proposta Barre 1 mt Proposal code 1 m Bars	Prezzo Price €
Alluminio naturale Natural aluminium	10	29	290	SPANA2G		SPANA1G	
Alluminio anodizzato argento Silver anodized aluminium	10	29	290	SPAAA2G		SPAAA1G	
Alluminio brillante Silver bright anodized aluminium	10	29	290	SPABA2G		SPABA1G	

									
10x2 20x2 30x2 40x2 50x2	10x10 20x20 30x30 40x40 50x50	20x10 30x15 40x10	8x8 10x10 15x15 20x20	20x18	10x1 12x1 16x1 20x1 24x1	20x10 30x15	20x20	10x10	20x20 30x15
5	5	3	4	1	5	2	1	1	2

PROPOSTA FAI DA TE ALLUMINIO ALUMINIUM DIY PROPOSALS

SMALL 2

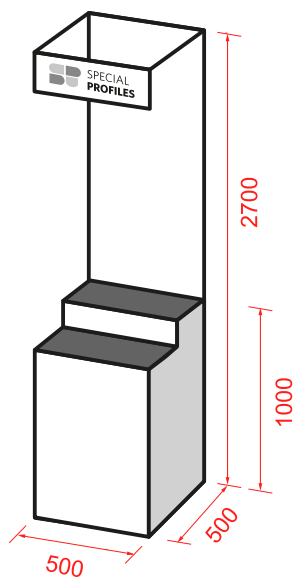

	pz / tipo pcs / type	Tot. referenze Total of references	Tot. barre Total of bars	Codice proposta Barre 2 mt Proposal code 2 m Bars	Prezzo Price €	Codice proposta Barre 1 mt Proposal code 1 m Bars	Prezzo Price €
--	-------------------------	---------------------------------------	-----------------------------	--	----------------------	--	----------------------

Alluminio naturale Natural aluminium	10	15	150	SPANA2P		SPANA1P	
Alluminio anodizzato argento Silver anodized aluminium	10	15	150	SPAAA2P		SPAAA1P	
Alluminio brillante Silver bright anodized aluminium	10	15	150	SPABA2P		SPABA1P	

20x2 30x2 40x2	20x20 30x30	40x10	20x20	20x18	12x1 16x1 20x1	20x10	20x20	10x10	20x20
3	2	1	1	1	3	1	1	1	1

PROPOSTA FAI DA TE ACCIAIO *STEEL DIY PROPOSALS*

BIG 2

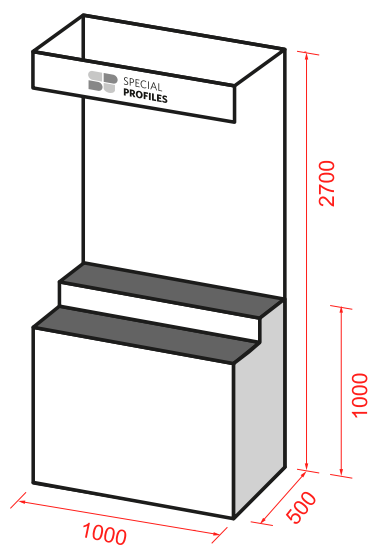



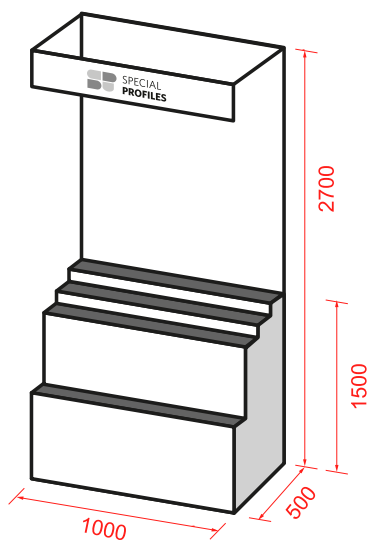

BIG 3

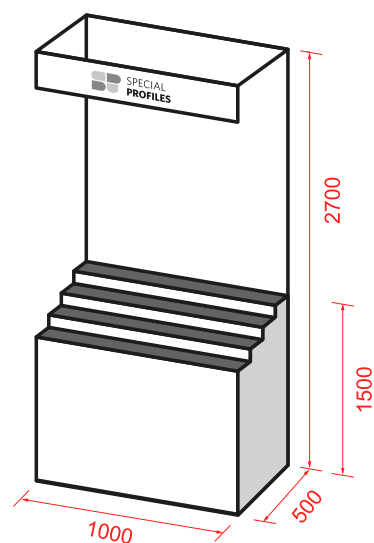

BIG 4



	pz / tipo pcs / type	Tot. referenze Total of references	Tot. barre Total of bars	Codice proposta Barre 2 mt Proposal code 2 m Bars	Prezzo Price €	Codice proposta Barre 1 mt Proposal code 1 m Bars	Prezzo Price €
Acciaio Steel	10	32	320	SPIL2G		SPIL1G	

			
10x0,25 20x0,25 30x0,25 40x0,25 50x0,25	10x10x0,25 20x20x0,25 30x30x0,25 40x40x0,25 50x50x0,25	20x10x0,25 30x15x0,25 40x10x0,25	10x15x0,25 15x15x0,25 20x20x0,25
10x0,7 20x0,7 30x0,7 40x0,7 50x0,7	10x10x0,7 20x20x0,7 30x30x0,7 40x40x0,7 50x50x0,7	20x10x0,7 30x15x0,7 40x10x0,7	10x15x0,7 15x15x0,7 20x20x0,7
10	10	6	6

PROPOSTA FAI DA TE ACCIAIO *STEEL DIY PROPOSALS*

SMALL 2

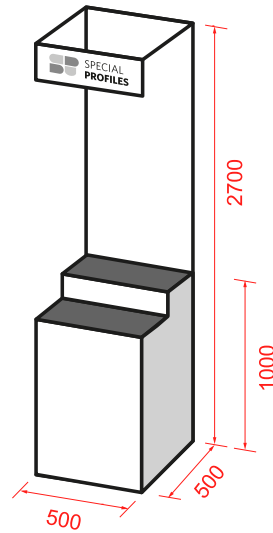

	pz / tipo pcs / type	Tot. referenze Total of references	Tot. barre Total of bars	Codice proposta Barre 2 mt Proposal code 2 m Bars	Prezzo Price €	Codice proposta Barre 1 mt Proposal code 1 m Bars	Prezzo Price €
--	-------------------------	---------------------------------------	-----------------------------	--	----------------------	--	----------------------

Acciaio Steel	10	16	160	SPIL2P		SPIL1P	
------------------	----	----	-----	--------	--	--------	--

10x0,7 20x0,7 30x0,7 40x0,7 50x0,7	10x10x0,7 20x20x0,7 30x30x0,7 40x40x0,7 50x50x0,7	20x10x0,7 30x15x0,7 40x10x0,7	10x15x0,7 15x15x0,7 20x20x0,7
5	5	3	3

PROPOSTA FAI DA TE FERRO *IRON DIY PROPOSALS*

BIG 2

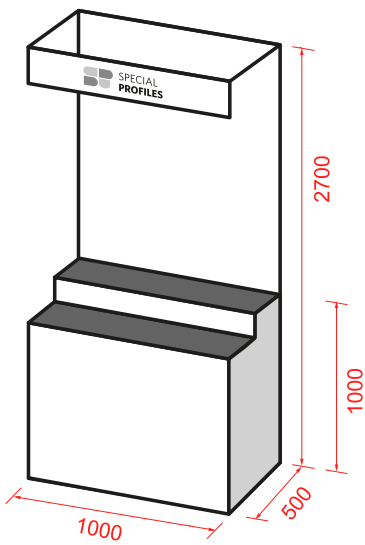



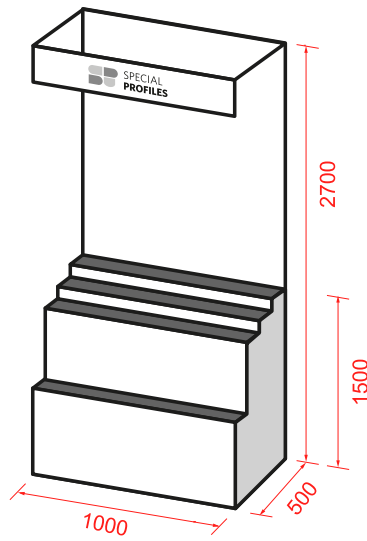



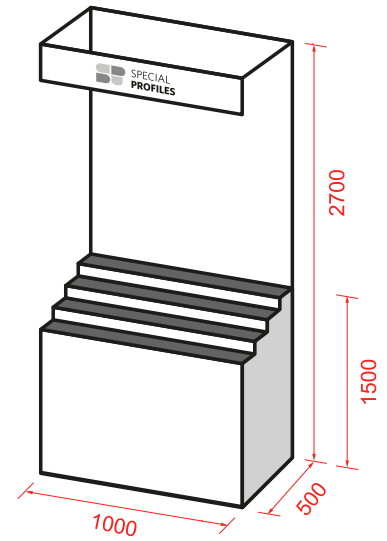



BIG 3



BIG 4



	pz / tipo pcs / type	Tot. referenze Total of references	Tot. barre Total of bars	Codice proposta Barre 2 mt Proposal code 2 m Bars	Prezzo Price €	Codice proposta Barre 1 mt Proposal code 1 m Bars	Prezzo Price €
Ferro Iron	6	24	144	SPFE2G		SPFE1G	

									
20x3 30x3 40x4 50x5	20x20x3 30x30x3 40x40x3	30x20x4 40x20x4	15x15x1,5 30x20x1,5	10 12	16x1,2 20x1,2 25x1,2 30x1,5	30x20x1,5 40x20x1,5	20x20x1,5 30x30x1,5	8x8 12x12	25x25x4
4	3	2	2	2	4	2	2	2	1

PROPOSTA FAI DA TE FERRO *IRON DIY PROPOSALS*

SMALL 2

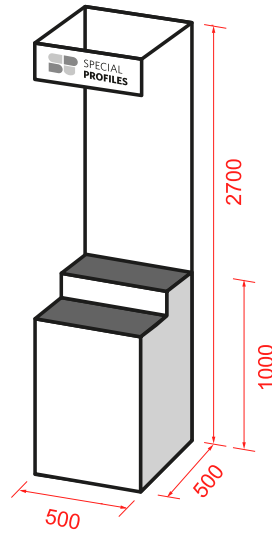

	pz / tipo pcs / type	Tot. referenze Total of references	Tot. barre Total of bars	Codice proposta Barre 2 mt Proposal code 2 m Bars	Prezzo Price €	Codice proposta Barre 1 mt Proposal code 1 m Bars	Prezzo Price €
Ferro Iron	6	14	84	SPFE2P		SPFE1P	

20x3 40x4	20x20x3 40x40x3	30x20x4	15x15x1,5	10 12	20x1,2 30x1,5	40x20x1,5	30x30x1,5	12x12	25x25x4
2	2	1	1	2	2	1	1	1	1





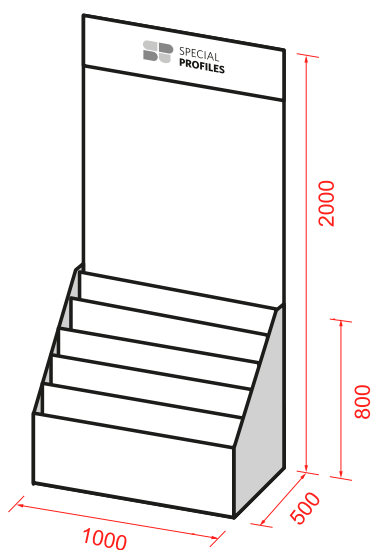

PROPOSTA FAI DA TE LAMIERE, ALLUMINIO, ACCIAIO
 ALUMINIUM, STEEL SHEETS, DIY PROPOSALS

BIG SLOTS



	pz / tipo pcs / type	Tot. referenze Total of references	Tot. lastre Total of sheets	Codice proposta Proposal code	Prezzo Price €
--	-------------------------	---------------------------------------	--------------------------------	----------------------------------	----------------------

Alluminio/Acciaio <i>Aluminium/Steel</i>	5	34	170	SPLA2G	
--	---	----	-----	---------------	--

Alluminio liscio naturale Natural aluminium sheet	Alluminio liscio anodizzato satinato Silver anodized aluminium sheet	Alluminio liscio anodizzato brillante Bright silver anodized aluminium sheet	Alluminio chicco di riso naturale Rice grain natural aluminium sheet	Acciaio liscio brillante Bright steel sheet	Lamiere stirate ferro, alluminio, acciaio Iron, aluminium, steel stretched sheets
					
500x200x0,25 500x500x0,25 500x1000x0,25	500x200x0,25 500x500x0,25 500x1000x0,25	500x200x0,25 500x500x0,25 500x1000x0,25	500x200x1,5 500x500x1,5	500x200x0,25 500x500x0,25 500x1000x0,25	400x500x1 400x500x1 400x500x1
500x200x0,7 500x500x0,7 500x1000x0,7	500x200x0,7 500x500x0,7 500x1000x0,7	500x200x0,7 500x500x0,7 500x1000x0,7	600x600x1,5 600x1000x1,5	500x200x0,7 500x500x0,7 500x1000x0,7	600x1000x1 600x1000x1 600x1000x1
6	6	6	4	6	3





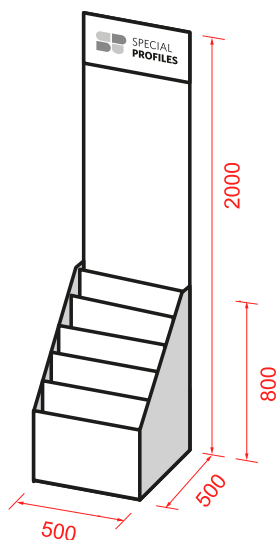

PROPOSTA FAI DA TE LAMIERE, ALLUMINIO, ACCIAIO
 ALUMINIUM, STEEL SHEETS, DIY PROPOSALS

SMALL SLOTS



	pz / tipo pcs / type	Tot. referenze Total of references	Tot. lastre Total of sheets	Codice proposta Proposal code	Prezzo Price €
--	-------------------------	---------------------------------------	--------------------------------	----------------------------------	----------------------





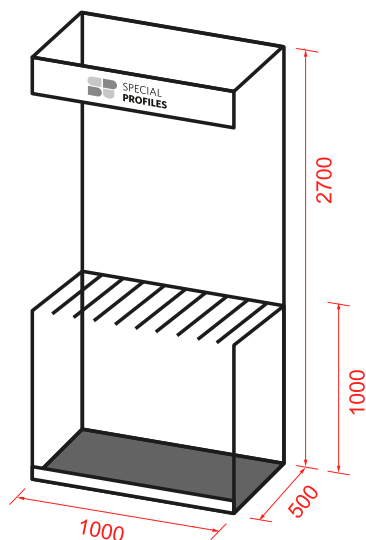





Alluminio/Acciaio <i>Aluminium/Steel</i>	5	17	85	SPLA1P	
--	----------	-----------	-----------	---------------	--





Alluminio liscio naturale Natural aluminium sheet 	Alluminio liscio anodizzato satinato Silver anodized aluminium sheet 	Alluminio liscio anodizzato brillante Bright silver anodized aluminium sheet 	Alluminio chicco di riso naturale Rice grain natural aluminium sheet 	Acciaio liscio brillante Bright steel sheet 	Lamiere stirate ferro, alluminio, acciaio Iron, aluminium, steel stretched sheets 
500x200x0,7 500x500x0,7 500x1000x0,7	500x200x0,7 500x500x0,7 500x1000x0,7	500x200x0,7 500x500x0,7 500x1000x0,7	500x200x1,5 500x500x1,5	500x200x0,7 500x500x0,7 500x1000x0,7	400x500x1 400x500x1 400x500x1
3	3	3	2	3	3

PROPOSTA CERAMICA, EDILIZIA
TILE, BUILDINGS SYSTEMS PROPOSALS
BIG TILE

Rivestimenti Mix <i>Mix Coverings</i>	pz / tipo <i>pcs / type</i>	Tot. referenze <i>Total of references</i>	Tot. prodotti <i>Total of bars</i>	Lunghezza Barre <i>Bar's Length</i> m	Codice proposta <i>Proposal code</i>	Prezzo <i>Price</i> €
--	--------------------------------	--	---------------------------------------	--	---	------------------------------------

Rivestimenti Mix <i>Mix Coverings</i>	10	25	250	mix	SPRIV2B	
--	----	----	-----	-----	---------	--





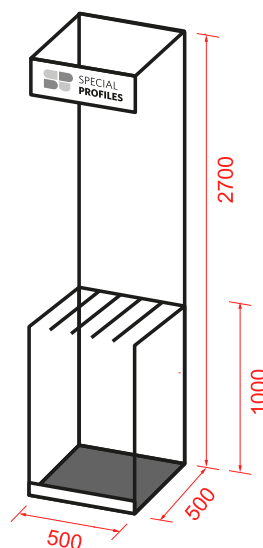





PVC bianco <i>PVC white</i>	PVC bianco <i>PVC white</i>	Alluminio <i>Aluminium</i>	Alluminio <i>Aluminium</i>	Acciaio <i>Steel</i>	Acciaio <i>Steel</i>	Alluminio <i>Aluminium</i>	Alluminio <i>Aluminium</i>	Acciaio <i>Steel</i>	Acciaio <i>Steel</i>
									
10 12	10 12	10 12	10 12	10 12	10 12	10 12	10 12	10 12	10 12
2	2	2	2	2	2	2	2	2	2





PVC bianco <i>PVC white</i>	PVC marrone <i>Brown PVC</i>	Alluminio <i>Aluminium</i>	Acciaio <i>Steel</i>	Acciaio <i>Steel</i>
				
22x22	28x28	25x25	30x30	30x30
1	1	1	1	1

PROPOSTA CERAMICA, EDILIZIA
TILE, BUILDINGS SYSTEMS PROPOSALS
SMALL TILE

	pz / tipo pcs / type	Tot. referenze Total of references	Tot. prodotti Total of bars	Lunghezza Barre Bar's Length m	Codice proposta Proposal code	Prezzo Price €
--	-------------------------	--	--------------------------------	--------------------------------------	----------------------------------	----------------------

Rivestimenti Mix <i>Mix Coverings</i>	10	15	150	mix	SPRIV2S	
---	-----------	-----------	------------	------------	----------------	--

PVC bianco PVC white	PVC bianco PVC white	Alluminio Aluminium	Alluminio Aluminium	Acciaio Steel	Acciaio Steel	Alluminio Aluminium	Alluminio Aluminium	Acciaio Steel	Acciaio Steel
									
10	10	10	10	10	10	10	10	10	10
1	1	1	1	1	1	1	1	1	1

PVC bianco PVC white	PVC marrone Brown PVC	Alluminio Aluminium	Acciaio Steel	Acciaio Steel
				
22x22	28x28	25x25	30x30	30x30
1	1	1	1	1





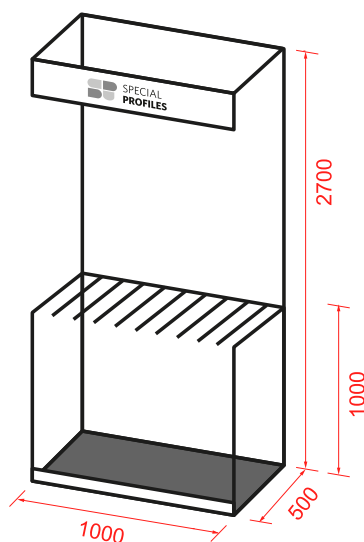



PROPOSTA CERAMICA, EDILIZIA
 TILE, BUILDING SYSTEMS PROPOSALS







BIG TILE



	pz / tipo pcs / type	Tot. referenze Total of references	Tot. prodotti Total of bars	Lunghezza Barre Bar's Length m	Codice proposta Proposal code	Prezzo Price €
--	-------------------------	---------------------------------------	--------------------------------	--------------------------------------	----------------------------------	----------------------

Rivestimenti PVC PVC Coverings	10	34	340	mix	SPJJ2B	
--	-----------	-----------	------------	------------	---------------	--





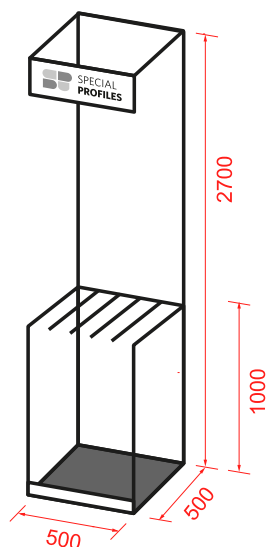

bianco white	avorio ivory	rosa pink	grigio grey	celeste light blue	rosa marmor. marbled pink	rosa pesca peach pink	beige chiaro light beige	beige sabbia sand beige	beige tabacco tobacco beige
									
6-8-10-12	8-10	8-10	8-10	8-10	8-10	8-10	8-10	8-10	8-10
4	2	2	2	2	2	2	2	2	2



travertino grigio travertine gray	crema yellow cream	travertino beige travertine beige	travertino beige travertine beige	verde brasil brazil green	grigio grey
					
8-10	8-10	8-10	8-10	8-10	8-10
2	2	2	2	2	2

PROPOSTA CERAMICA, EDILIZIA
TILE, BUILDING SYSTEMS PROPOSALS
SMALL TILE









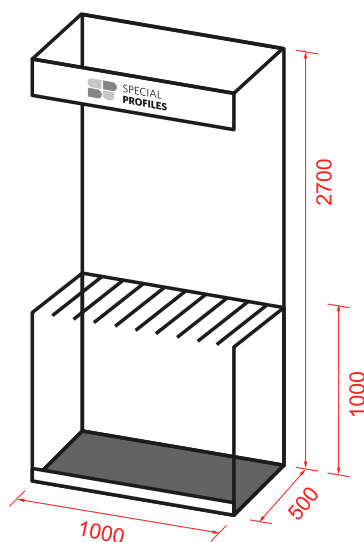







	pz / tipo pcs / type	Tot. referenze Total of references	Tot. prodotti Total of bars	Lunghezza Barre Bar's Length m	Codice proposta Proposal code	Prezzo Price €
--	-------------------------	--	--------------------------------	--------------------------------------	----------------------------------	----------------------

Bagno <i>Bathroom</i>	10	15	150	mix	SPSA2S	
---------------------------------	----	----	-----	-----	--------	--









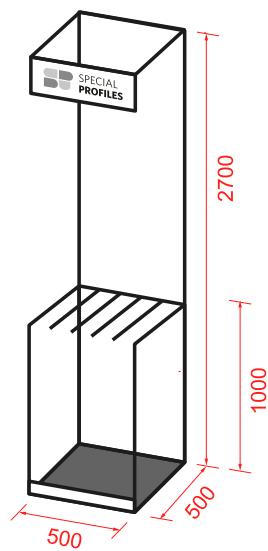







SpecialSanit-PVC	SpecialCapsI-PVC	SpecialCapsE-PVC	SpecialCapsT-PVC	SpecialProtec-PVC	SpecialProtec-PVC	SpecialCapPI-PVC SpecialCapPE-PVC
						
20x20	20	20	20	8	10	8 10
1	1	1	1	1	1	4

SpecialSanit-AL argento + brillante <i>silver + bright</i>	SpecialProtec-AL argento + brillante <i>silver + bright</i>	SpecialSanit-PVC
		
18x18	10x10	45x45
2	2	1

PROPOSTE PAVIMENTO ALLUMINIO, ACCIAIO
ALUMINIUM, STEEL FLOOR PROPOSALS
BIG TILE

	pz / tipo pcs / type	Tot. referenze Total of references	Tot. prodotti Total of bars	Lunghezza Barre Bar's Length m	Codice proposta Proposal code	Prezzo Price €	
Pavimento Floor	10	29	290	mix	SPFL2B		
alluminio argento silver aluminium	alluminio argento silver aluminium	alluminio argento silver aluminium	all. argento + brillante bright + silver al.	acciaio steel	all. argento + brillante bright + silver al.	acciaio steel	arg. + brillante bright + silver al.
							
42x26	12,5	12,5	30	16-30	25	25	20x9
1	1	1	2	2	2	1	2
all. nat. + arg. + brillante natural + bright + silver al.	all. argento + brillante bright + silver al.	acciaio steel	alluminio argento silver aluminium	acciaio steel	all. argento + brillante bright + silver al.	acciaio steel	acciaio steel
							
5x25	8-10-12,5	10-12,5	10	10	12,5	12,5	10
3	6	2	1	1	2	1	1

PROPOSTE PAVIMENTO ALLUMINIO, ACCIAIO
ALUMINIUM, STEEL FLOOR PROPOSALS
SMALL TILE

	pz / tipo pcs / type	Tot. referenze Total of references	Tot. prodotti Total of bars	Lunghezza Barre Bar's Length m	Codice proposta Proposal code	Prezzo Price €	
Pavimento Floor	10	18	180	mix	SPFL2S		
alluminio argento silver aluminium	alluminio argento silver aluminium	alluminio argento silver aluminium	all. argento + brillante bright + silver al.	acciaio steel	all. argento + brillante bright + silver al.	acciaio steel	arg. + brillante bright + silver al.
							
42x26	12,5	12,5	30	16	25	25	20x9
1	1	1	1	1	1	1	1
all. nat. + arg. + brillante natural + bright + silver al.	all. argento + brillante bright + silver al.	acciaio steel	alluminio argento silver aluminium	acciaio steel	all. argento + brillante bright + silver al.	acciaio steel	acciaio steel
							
5x25	10-12,5	10-12,5	10	10	12,5	12,5	10
1	2	2	1	1	1	1	1

Alluminio
Aluminium



Ferro
Iron



Profili per Ceramica
Tile profiles



Profili portaetichette
Label holder profiles



Descrizione etichetta
Label description

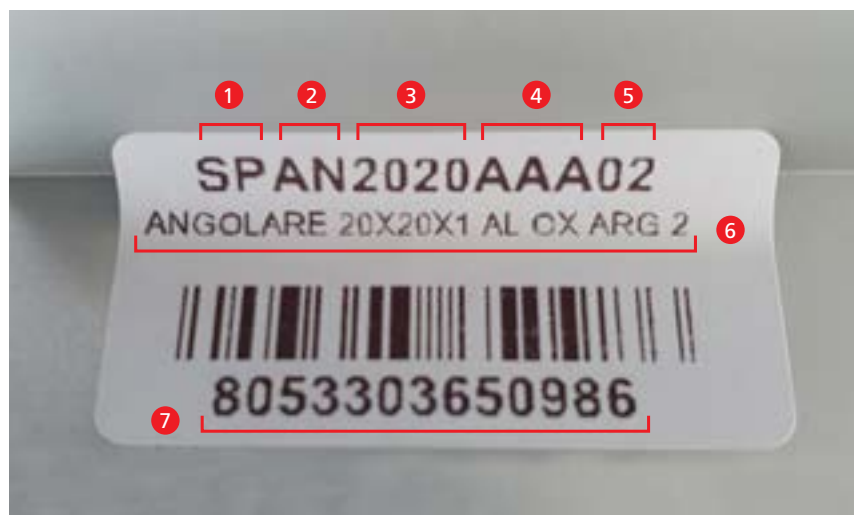

- 1- Codice azienda - *Company code*
- 2- Tipo prodotto - *Item type*
- 3- Misura prodotto - *Item size*
- 4- Finitura - *Finish*
- 5- Lunghezza profilo - *Item length*
- 6- Descrizione prodotto - *Item description*
- 7- Barcode EAN13 - *EAN13 code*

Principali caratteristiche delle materie prime utilizzate da Special Profiles

ALLUMINIO

Lega di alluminio (Al-Mg-Si)

I profili sono realizzati per estrusione oppure laminazione e successiva pressopiegatura.

Presentano ottima resistenza ai principali agenti chimici ed atmosferici.

Trattamenti superficiali tramite impianti di proprietà dell'azienda, trasformano il materiale in :

- Alluminio anodizzato: ossidazione anodica con 8-10 micron di spessore dell'ossido.
- Alluminio Brillantato: ossidazione anodica con 8-10 micron di spessore dell'ossido.
- Alluminio Verniciato: a polveri, con circa 100 micron di spessore della verniciatura.

Non consigliati per utilizzo a pavimento.

ACCIAIO INOX - AISI 304

I profili sono realizzati per laminazione e successiva pressopiegatura.

Presentano ottima resistenza ai principali agenti chimici ed atmosferici e ottima resistenza meccanica

Trattamenti superficiali tramite impianti proprietari dell'azienda, trasformano il materiale in :

Acciaio Lucido e Brillante.

Utilizzo sia a parete che a pavimento, in ambiente ospedaliero, alimentare, etc.

- Attenzione: i bordi di taglio non sono inossidabili

PVC Rigido (Paraspigoli)

Cloruro di vinile rigido esente da piombo, antiurto, autoestinguento.

Buona resistenza meccanica e all'abrasione.

PVC Co-estruso - Rigido/Morbido (Giunti di dilatazione)

Cloruro di vinile rigido coestruso con PVC morbido esente da piombo, antiurto, autoestinguento.

Ottima resistenza meccanica, all'abrasione.

PE-HD (Distanziatori per mattonelle)

Polietilene ad alta densità, resina termoplastica, ottima stabilità chimica e resistenza meccanica. L'alta densità(HD) aumenta la sua rigidità.

POLIPROPILENE (Angoli esterni quadrati e tondi)

Polimero termoplastico, semicristallino, con buona resistenza meccanica e all'abrasione.

Manutenzione

Evitare il contatto diretto con cemento e suoi derivati, se umidi, prodotti decalcificanti e detergenti che contengono cloro.

Evitare l'uso di prodotti abrasivi che possano graffiare (spugne abrasive/pagiette metalliche).

Subito dopo la posa procedere con una accurata pulizia delle superfici con abbondante acqua/prodotti a PH neutro/ non alcalini, in particolare rimuovere cemento, colla dalle superfici in vista.

Misure e tolleranze

Tutte le informazioni ed i disegni contenuti nel presente catalogo hanno carattere non impegnativo e soggette a variazione, senza preavviso.

Tutti i dati dimensionali fanno riferimento a quote nominali, soggette a tolleranze meccaniche, secondo la norma En-22768 ISO-2768 -m.

**Main characteristics of the raw materials used
by Special Profiles****ALUMINUM**

Aluminum alloy (Al-Mg-Si)

The profiles are made by extrusion or lamination and subsequent press bending.

They have excellent resistance to the main chemical and atmospheric agents.

Surface treatments through the company's proprietary systems, transform the material into:

Anodized aluminum: anodic oxidation with 8-10 microns of oxide thickness.

Polished Aluminum: anodic oxidation with 8-10 microns of oxide thickness.

Painted Aluminum: powder coated, with about 100 microns of paint thickness.

Not recommended for floor use.

STAINLESS STEEL - AISI 304

The profiles are made by rolling and subsequent press bending.

They have excellent resistance to the main chemical and atmospheric agents and excellent mechanical resistance

Surface treatments through the company's systems, transform the material into:

Polished and bright steel.

Use both on the wall and on the floor; in hospitals, food, industry.

- Attention: the cutting edges are not stainless

Rigid PVC (Corner protectors)

Lead-free, impact-resistant, self-extinguishing rigid vinyl chloride.

Good mechanical and abrasion resistance.

Co-extruded PVC - Rigid / Soft (expansion joints)

Co-extruded rigid vinyl chloride with soft PVC, lead-free, shockproof, self-extinguishing.

Excellent mechanical resistance, to abrasion.

PE-HD (Tile spacers)

High density polyethylene, thermoplastic resin, excellent chemical stability and mechanical resistance. The high density (HD) increases its stiffness.

POLYPROPYLENE (External square and round corners)

Thermoplastic polymer; semi-crystalline, with good mechanical and abrasion resistance.

Maintenance

Avoid direct contact with concrete and its derivatives, if wet, descaling products and detergents that contain chlorine.

Avoid using abrasive products that can scratch (abrasive sponges / metal wool).

Immediately after laying proceed with a thorough cleaning of the surfaces with plenty of water / neutral / non-alkaline PH products, in particular remove cement, glue from the exposed surfaces.

Measures and tolerances

All information and drawings contained in this catalog are non-binding and subject to change without notice. All dimensional data refer to nominal dimensions, subject to mechanical tolerances, according to the En-22768 ISO-2768 -m standard.

Condizioni generali di vendita

General conditions of sale

Sezione 1 - Condizioni Generali

- (1) I seguenti termini e condizioni generali di contratto si applicano per tutti i beni e servizi forniti a una specifica commessa, una persona giuridica di diritto pubblico o di un fondo speciale di diritto pubblico.
- (2) Se un cliente ha termini e condizioni di vendita diverse dalle nostre, e queste ultime non sono state esplicitamente loro riconosciute, le stesse sono da ritenersi non vincolanti per Mecc.AI, anche se non esplicitamente respinte.
- (3) L'acquisizione e l'interpretazione di questi termini e condizioni di vendita generali devono essere esclusivamente disciplinati dalla legge Italiana, così come la conclusione e l'interpretazione dei negozi giuridici con il cliente. L'applicazione della legge delle Nazioni Unite sulle vendite (CISG) è espressamente rifiutata.
- (4) La nullità di singole disposizioni o elementi di questi termini e condizioni di vendita generali non pregiudica la validità delle restanti disposizioni.
- (5) Il luogo di adempimento per gli obblighi creati direttamente o indirettamente dal rapporto contrattuale, compreso l'obbligo di rendere il pagamento, sarà la nostra sede aziendale.
- (6) L'esclusivo foro competente è quello in cui si trova la nostra sede aziendale.

Sezione 2 - Quotazioni, ambito di prestazione e stipula del contratto

- (1) Le nostre quotazioni generate e pertinenti ad uno specifico contratto sono soggette a possibili modifiche senza preavviso. Gli ordini sono per noi vincolanti solo nella misura in cui vengono confermati. Qualsiasi tipo di diverso accordo verbale è da ritenersi valido soltanto se confermato per iscritto.
- (2) La nostra conferma d'ordine ha il solo valore di definire la tipologia delle prestazioni contrattualmente dovute.
- (3) Ci riserviamo il diritto di modificare il progetto, la scelta dei materiali, le specifiche dello stesso ed il metodo di costruzione, anche dopo l'invio al cliente della conferma d'ordine, a condizione che tali modifiche non siano in contraddizione né con la conferma d'ordine né con le specifiche del cliente.
- (4) I documenti su cui la quotazione o la conferma d'ordine si basano, quali diagrammi e disegni, dimensioni e dichiarazioni di peso sono, di regola, solo approssimazioni e pertanto non sono vincolanti, purché non espressamente dichiarato per iscritto.
- (5) Sono ammesse consegne parziali.
- (6) Il nostro obbligo di fornitura è sospeso dal momento in cui il cliente risulta inadempiente agli obblighi presi.
- (7) In caso di commesse in conto lavoro, il cliente è tenuto a fornirci tutto il materiale e le documentazioni tecniche necessarie per la fornitura nei dovuti tempi e a proprie spese. Il materiale deve essere perfetto e rispettare i valori specifici indicati e possedere i sovrametalli normali nel settore. Il cliente si assume la responsabilità per le condizioni di garanzia e qualità del materiale fornitoci in conto lavoro. Si accolla inoltre i costi e le eventuali perdite aggiuntive sostenute da Mecc.AI a causa di materiale non avente le dovute caratteristiche tecniche e di qualità garantite.

Sezione 3 - prezzi, termini e condizioni di pagamento

- (1) I prezzi applicati, se non diversamente specificato per iscritto in quotazione o conferma d'ordine, sono da intendersi franco fabbrica, escludendo gli altri costi di spedizione e di trasporto. Se la consegna è concordata con incluso il trasporto, i prezzi indicati da noi relativi al trasporto stesso si basano sulle spese e le altre variabili pertinenti in vigore al momento della quotazione. I prezzi potranno di conseguenza variare, a favore o sfavore del cliente, al variare di queste condizioni nel lasso di tempo che intercorre tra la quotazione e la spedizione del materiale ordinato, senza che il cliente abbia alcun diritto di recedere dal contratto per questo motivo.
- (2) Se trascorrono più di quattro mesi tra la firma del contratto e la consegna dei materiali ordinati, senza che sussistano responsabilità da parte di Mecc.AI per il ritardo nella consegna, il prezzo dei materiali ordinati potrà aumentare a seconda del caso prendendo in considerazione i costi della materia prima, gli stipendi ed eventuali altri costi accessori sostenuti da Mecc.AI in questo lasso di tempo. Se il prezzo di acquisto aumenta di oltre il 30%, il cliente ha il diritto di recedere dal contratto.
- (3) Se dovessero pervenire richieste di modifica ai materiali ordinati da parte del cliente, i costi aggiuntivi sostenuti a seguito di queste modifiche verranno addebitati e fatturati al cliente.
- (4) Le nostre fatture devono essere saldate per intero in base alle condizioni contrattuali di pagamento concordate tra le parti ed indicate in fattura.
- (5) Se il cliente supera la data di pagamento concordata, Mecc.AI si riserva il diritto di pretendere interessi passivi pari a 8 punti % superiori al tasso bancario in vigore in quel momento.
- (6) Se l'acquirente è in ritardo sul pagamento e presunti giustificati dubbi sulla sua capacità di pagare la somma di nostra proprietà a titolo di credito diventano evidenti, Mecc.AI, indipendentemente da altri nostri diritti, è autorizzata ad esigere il pagamento in anticipo per ulteriori nuove consegne allo scopo di rendere tutti i nostri crediti derivanti dal rapporto commerciale pagabili immediatamente.

Sezione 4 - Spedizione

Il carico dei materiali ordinati e la spedizione degli stessi sono effettuati senza assicurazione e a rischio del destinatario. Eventuali costi aggiuntivi derivanti da condizioni particolari non preventivamente concordate saranno a carico del compratore - anche se i termini di consegna concordati includono il trasporto.

Sezione 5 - Termini di consegna

- (1) La definizione dei tempi di consegna deve essere considerata non vincolante per Mecc.AI. La

produzione deve essere comunque eseguita al meglio delle nostre conoscenze e competenze e può essere prolungata a seconda dei casi, in particolare nel caso in cui l'acquirente si astenga dal fornire la sua necessaria e concordata assistenza. Lo stesso vale per le misure adottate in risposta alle loro controversie, in particolare nel caso in cui eventi imprevisi fuori dal nostro controllo dovessero verificarsi; scioperi e serrate, ritardi nelle consegne di componenti da un nostro fornitore, imprevisi derivanti dal trasporto e da interruzioni operative, carenza di materia prima, interruzioni di corrente, ecc.

- (2) Modifiche fatte ai materiali ordinati su specifica richiesta del cliente generano di conseguenza un congruo posticipo della data di consegna concordata.

Sezione 6 - trasferimento del rischio

- (1) Il rischio di perdita accidentale o deterioramento del materiale ordinato passa al cliente non appena il materiale stesso viene prodotto e ne viene data comunicazione al cliente.

Sezione 7 - Riserva di proprietà

- (1) Ci riserviamo il titolo di proprietà delle merci fornite fino a quando non sia stato effettuato il loro pagamento per intero. La riserva di proprietà si applica anche su tutti i crediti esistenti nel rapporto tra noi ed il cliente, compresi quelli pertinenti a materiali oggetto di reclamo, sino a che le controversie non siano dichiarate risolte ed il pagamento dei materiali oggetto di reclamo sia effettuato per intero.
- (2) Il cliente non è autorizzato a vendere o disporre in alcuna maniera del materiale oggetto dalla fattura di vendita non pagata, compreso cederlo in garanzia a terzi. Non è altresì autorizzato a rivendere tale materiale nel contesto di una propria transazione commerciale. Qualsiasi procedura esecutiva promossa da terzi che abbia per oggetto i materiali deve essere immediatamente portata a conoscenza di Mecc.AI.
- (3) In osservanza del diritto di proprietà come sopra previsto a favore di Mecc.AI, il cliente deve astenersi dal porre in essere atti o comportamenti tali da impedire a Mecc.AI il valido esercizio di tale diritto.
- (4) In caso di violazione dell'obbligazione del cliente come prevista dal presente articolo, Mecc.AI ha il diritto di revocare con effetto immediato tutti gli ordini dei materiali non ancora prodotti.

Sezione 8 - reclami in garanzia

- (1) In concomitanza con una transazione commerciale tra le due parti nel contesto del contratto, il cliente deve ispezionare il materiale immediatamente al momento della consegna, intendendo che ciò sia utile e funzionale al buon andamento della transazione. Nel caso venga riscontrato un difetto nei materiali forniti, il cliente ha l'obbligo di comunicarlo a Mecc.AI entro 8 giorni dal ricevimento dei materiali stessi. In assenza di comunicazione, il materiale viene considerato accettato, a meno che non si tratti di un difetto che non avrebbe potuto essere identificato durante l'ispezione iniziale.
 - (2) Nella misura in cui i beni hanno un difetto per il quale Mecc.AI è ritenuta responsabile, e il cliente ha notificato il difetto per iscritto in tempo utile, Mecc.AI si impegna a porre rimedio alla situazione (ed il cliente non ha il diritto di recedere dal contratto o ridurre il prezzo di acquisto) a meno che non venga espressamente dichiarato da Mecc.AI di rifiutare di porre rimedio a difetto sulla base delle norme di legge. Il cliente dovrà comunque concederci un ragionevole periodo di tempo per porre rimedio ad ogni difetto riscontrato. I materiali contestati possono essere altresì sostituiti con la fornitura di nuovi. Il prezzo di acquisto non può essere ridotto né può il cliente recedere dal contratto, mentre una azione di rimedio da parte di Mecc.AI è in corso.
 - (3) I diritti di garanzia vanno in prescrizione un anno dopo che le merci sono state consegnate.
- Prezzi:
I prezzi indicati nel listino Special Profiles sono in euro e non comprendono l'IVA. La fatturazione avviene al pezzo.

Confezioni di vendita

- 10 pz. su tutto, 5 pz. su lamiera, 6 pz. su ferro.

Sconfezionamento

- Maggiorazione del 10% sul listino in vigore.

Ordini

Specificare SEMPRE nei Vostri ordini l'unità di misura relativa alle quantità indicate. In mancanza di essa, verranno SEMPRE considerata in PEZZI.

Consegne

Dal pronto. Successive spedizioni parziali per mancanza di merce saranno in porto franco, purché l'importo sia superiore al minimo evadibile.

Reso merce:

I resi verranno accettati solo previa compilazione del modulo apposito e successiva autorizzazione da parte di Special Profiles.

Special Profiles a brand of Mecc.AI Group

Via dei Laghi, 4 - Calcinelli 61036 Colli al Metauro (PU) - Italia
Tel. +39.0721.8764.201
www.special-profiles.com

Section 1 - General Conditions

(1) The following general terms and conditions of contract apply for all goods and services provided to a specific job order, a legal person governed by public law or of a special fund under public law.

(2) If a customer has different terms and conditions of sale than ours, and these the latter have not been explicitly recognized to them, they are to be considered not binding on Mecc.AI, even if not explicitly rejected.

(3) The acquisition and interpretation of these terms and conditions of sale

Generals must be exclusively governed by Italian law, as well as the conclusion and interpretation of legal stores with the client. The application of the United Nations Sales Act (CISG) is expressly rejected.

(4) The nullity of individual provisions or elements of these terms and conditions of General sales do not affect the validity of the remaining provisions.

(5) The place of performance for obligations created directly or indirectly from the contractual relationship, including the obligation to make the payment, will be the our corporate headquarters.

(6) The exclusive place of jurisdiction is the one where our company headquarters are located.

Section 2 - Quotes, scope of performance and conclusion of the contract

(1) Our quotes generated and relevant to a specific contract are subject to possible changes without notice. Orders are binding on us only to the extent that they are confirmed. Any kind of different arrangement minutes are to be considered valid only if confirmed in writing.

(2) Our order confirmation has the only value of defining the typology of the contractually due services.

(3) We reserve the right to modify the design, the choice of materials, the specifications of the same and the method of construction, even after being sent to customer of the order confirmation, provided that these changes are not in contradiction neither with the order confirmation nor with the customer's specifications.

(4) The documents on which the quote or order confirmation are based, such as diagrams and drawings, dimensions and weight declarations are, as a rule, only approximations and therefore are not binding, as long as not expressly declared in writing.

(5) Partial deliveries are allowed.

(6) Our supply obligation is suspended from the moment the customer appears breach of obligations.

(7) In the case of subcontracting orders, the customer is obliged to provide us with all material and technical documentation necessary for the delivery in due times and own expense. The material must be perfect and respect the values specific indicated and possess the normal allowances in the sector. The customer assumes the responsibility for the conditions of guarantee and quality of the material supplied to us on account work. It also takes over the costs and any additional losses incurred by Mecc.AI because of material that does not have the necessary technical and quality characteristics Guaranteed.

Section 3 - prices, terms and conditions of payment

(1) The prices applied, unless otherwise specified in writing in the quotation or order confirmation, are to be understood ex works, excluding the other costs of shipping and transportation. If the delivery is agreed with including transportation, the prices indicated by us relating to the transport itself are based on expenses and others relevant variables in effect at the time of listing. Prices will be able to consequently vary, in favor or disadvantage of the customer, as these conditions vary in the time that elapses between the quotation and the shipment of the material ordered, without the customer having any right to withdraw from the contract for this reason.

(2) If more than four months elapse between the signing of the contract and the delivery of the materials ordered, without any liability on the part of Mecc.AI for the delay in delivery, the price of the materials ordered may increase depending of the case taking into consideration the costs of the raw material, the wages and any other ancillary costs incurred by Mecc.AI during this period. If the purchase price increases by more than 30%, the customer has the right to withdraw from contract.

(3) If requests for modification to the materials ordered by the customer, additional costs incurred as a result of these changes will be charged and billed to the customer.

(4) Our invoices must be paid in full according to the conditions payment agreements agreed between the parties and indicated on the invoice.

(5) If the customer exceeds the agreed payment date, Mecc.AI reserves the right to claim interest expense equal to 8% points higher than the current bank rate in that moment.

(6) If the buyer is late on the payment and suspected justified doubts about the his ability to pay the sum of our property by way of credit become evident, Mecc.AI, independently of our other rights, is authorized to demand payment in advance for further new deliveries for the purpose of making all our trade credit claims payable immediately.

Section 4 - Shipping

The loading of the ordered materials and their shipment are carried out without insurance and at the risk of the recipient. Any additional costs resulting from conditions details not previously agreed will be paid by the buyer - even if the agreed delivery terms include transportation.

Section 5 - Delivery terms

(1) The definition of delivery times must be considered non-binding for Mecc.AI. The production must however be performed to the best of our knowledge and skills and can be prolonged as appropriate, particularly in the in the event that the buyer refrains from providing his necessary and agreed assistance.

The same applies to the measures taken in response to their disputes, in particular in the event that unforeseen events beyond our control should occur; strikes e lockouts, delays in deliveries of components from one of our suppliers, unforeseen incidents from transport and operational interruptions, shortage of raw materials, interruptions of current, etc.

(2) Modifications made to the materials ordered upon specific customer request generate consequently a reasonable postponement of the agreed delivery date.

Section 6 - transfer of risk

(1) The risk of accidental loss or deterioration of the ordered material it passes to the customer as soon as the material itself is produced and it is communicated to the client.

Section 7 - Retention of title

(1) We reserve the title to the goods supplied until it has been paid in full. The retention of title also applies to everyone the credits existing in the relationship between us and the customer, including those pertinent to materials object of complaint, until disputes are declared resolved and payment of the materials subject to complaint is made in full.

(2) The customer is not authorized to sell or dispose of the in any way material covered by the unpaid sales invoice, including transferring it as guarantee to third parties. It is also not authorized to resell such material in the context of a own commercial transaction. Any executive procedure promoted by third parties who have as their object the materials must be immediately brought to knowledge of Mecc.AI.

(3) In compliance with the property right as provided above in favor of Mecc.AI, the customer must refrain from engaging in acts or conduct that would prevent a Mecc.AI the valid exercise of this right.

(4) In case of violation of the client's obligation as provided for in this article, Mecc.AI has the right to revoke all orders from materials not yet produced.

Section 8 - warranty claims

(1) In conjunction with a commercial transaction between the two parties in the context of the contract, the customer must inspect the material immediately at the time of delivery, meaning that this is useful and functional to the good performance of the transaction. If a defect is found in the materials supplied, the customer has the obligation to communicate it to Mecc.AI within 8 days of receipt of the materials themselves. In the absence of communication, the material is considered accepted, unless that it is not a defect that could not have been identified during the initial inspection.

(2) To the extent that the goods have a defect for which Mecc.AI is held responsible, and the customer has notified the defect in writing in good time, Mecc.AI undertakes to remedy the situation (and the customer has no right to withdraw from the contract or reduce the purchase price) unless it comes expressly declared by Mecc.AI to refuse to remedy a defect on the basis of the law. The customer will still have to give us a reasonable period of time to remedy any defect found. The materials disputed can also be replaced with the supply of new ones. The price of purchase cannot be reduced nor can the customer withdraw from the contract while a remedial action by Mecc.AI is in progress.

(3) Warranty claims become time-barred one year after the goods have been delivered.

Prices

Prices in Special Profiles price list are in euro, without VAT. Invoicing by piece.

Sales packaging

- 10 pcs. over all, 5 pcs. on sheets, 6 pcs. on iron.

Unpack

- 10% surcharge on the current price list.

Orders

ALWAYS specify in your orders the unit of measurement relating to the indicated quantities. In absence of it, they will ALWAYS be considered in PIECES.

Deliveries

From stock. Subsequent partial shipments for lack of goods will be free delivered provided that the amount is greater than the minimum executable amount.

Returned goods

Returns will be accepted only after completing the appropriate form and subsequent authorization by Special Profiles.

Special Profiles a brand of Mecc.AI Group

Via dei Laghi, 4 - Calcinelli 61036 Colli al Metauro (PU) - Italy

Tel. +39.0721.8764.202

www.special-profiles.com

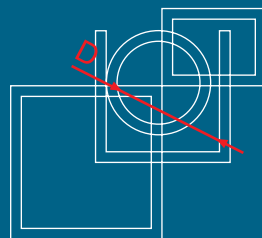

SPECIAL PROFILES

by **MECC.AL. Srl**

Via dei Laghi, 4 - Calcinelli 61036

Colli al Metauro - PU - Italy

Tel: + 39 0721 876 4201 (IT)

Tel: + 39 0721 876 4202 (EN)

specialprofiles@meccal.com



www.special-profiles.com