

Profili e Sistemi innovativi
Innovative Profiles and Systems

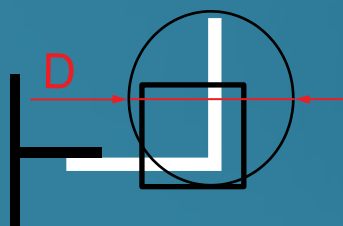

**SPECIAL
PROFILES**



Listino Prezzi 23/01
Price List 23/01

2023



Special Profiles

Special Profiles nasce dal know how e dall'esperienza trentennale di Mecc.Al, azienda leader mondiale nella progettazione e produzione di Alluminio. Col nuovo brand "Special Profiles", realizza e distribuisce una gamma completa di profili e lamiere per i settori del Fai da Te, posa dei pavimenti e rivestimenti, sia a livello civile che industriale, in tutto il mondo.

Special Profiles

Special Profiles was born from the know-how and thirty year experience of Mecc.Al, a world leader in the design and production of aluminum. With the new brand "Special Profiles", it creates and distributes a complete range of profiles and metal sheets for the DIY sectors, laying floors and walls, both civil and industrial, worldwide.

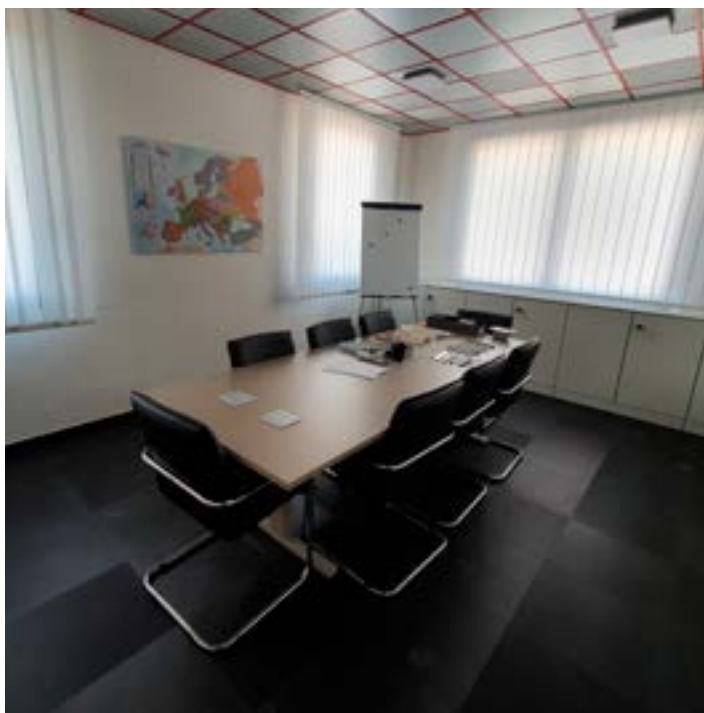

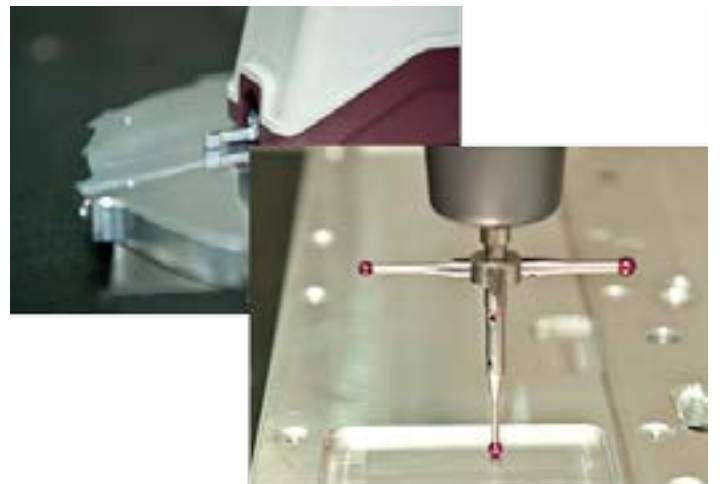

Special Profiles

sfruttando le enormi risorse del Gruppo di appartenenza, parte dalle materie prime per produrre in autonomia tutti i semilavorati necessari per la produzione dei prodotti finiti. Qualità, Flessibilità, Affidabilità, Competitività sono alcuni dei vantaggi a Vostra disposizione.

Using the huge resources of the Group to which it belongs, Special Profile starts from raw materials to independently produce all the semi-finished products necessary for the production of finished products. Quality, Availability, Flexibility, Reliability, are some of the advantages available to you.

Special Profiles

utilizza per la produzione dei prodotti macchine e sistemi di ultima generazione: anche tutti i trattamenti superficiali sono realizzati al suo interno. Un magazzino efficace ed efficiente, unitamente ad una logistica all'avanguardia, permettono consegne entro le 48 ore dall'ordine.

Special Profiles entirely produces its products within the Company, guaranteeing Quality and Service. Thanks to the latest generation of machines and systems, all surface treatments are also carried out internally. An effective and efficient warehouse, together with cutting-edge logistics, allow deliveries within 48 hours.





Servizio Clienti

L'intero team Special Profiles è a Vostra completa disposizione per qualsiasi tipo di suggerimento e supporto. Grazie alla nostra rete capillare di agenti su tutto il territorio potete beneficiare di un immediato contatto professionale. Il tutto supportato anche dal nostro personale interno. Non esitate a contattarci, usando i nostri riferimenti.

Customer Care

The whole Special Profiles team is at your complete disposal for any suggestion and support. Thanks to our network of agents throughout the territory, you can benefit from immediate professional contact. All supported also by our internal staff. Do not hesitate to contact us, using our references.



Tel. +39 0721 876 4205 (IT)

Tel. +39 0721 876 4206 (EN)

E-Mail specialprofiles@meccal.com

Web www.special-profiles.com



**QUALITY SYSTEM
CERTIFICATION
DNV-GL
ISO 9001**

**QUALITY SYSTEM
CERTIFICATION
DNV-GL
IATF 16949**

**QUALITY SYSTEM
CERTIFICATION
DNV-GL
ISO 14001**



Le certificazioni per la Qualità Quality certifications

La ricerca della qualità in tutti gli aspetti della produzione è uno dei punti fondamentali di Special Profiles, certificata dall'ente internazionale DNV secondo la norma UNI EN ISO 9001:2015, grazie anche ad un'accurata politica di selezione e controllo rivolta verso i nostri partner e fornitori.

Un prodotto di alta qualità, affidabile ed esauriente, la capacità manifatturiera, il personale dedito e qualificato ed il rispetto rigoroso dei celeri tempi di consegna sono i punti di forza di Special Profiles, partner ideale per tutte le esigenze nell'ambito dei Profili per il fai da te, per le costruzioni, per la posa di pavimenti e rivestimenti.

Il nostro impegno nella qualità si rivolge allo stesso tempo al rispetto della salute umana ed ambientale, offrendo prodotti conformi alle direttive RoHS e REACH che limitano la presenza di sostanze pericolose nella produzione : la nostra certificazione ISO 14001 ne è la prova tangibile.

The search for quality in all aspects of production is one of the fundamental points of Special Profiles, certified by the DNV international body, according to the UNI EN ISO 9001: 2015 standard, thanks also to an accurate selection and control policy aimed at our partners and suppliers. A high quality, reliable and comprehensive product, manufacturing capacity, dedicated and qualified staff and rigorous respect for fast delivery times are the strength of Special Profiles, the ideal partner for all needs in the field of Profiles for do-it-yourself, construction, for laying floors and walls.

Our commitment to quality is aimed at the same time to respect human and environmental health, offering products compliant with the RoHS and REACH directives which limit the presence of dangerous substances in production: our ISO 14001 certification is tangible proof of this.

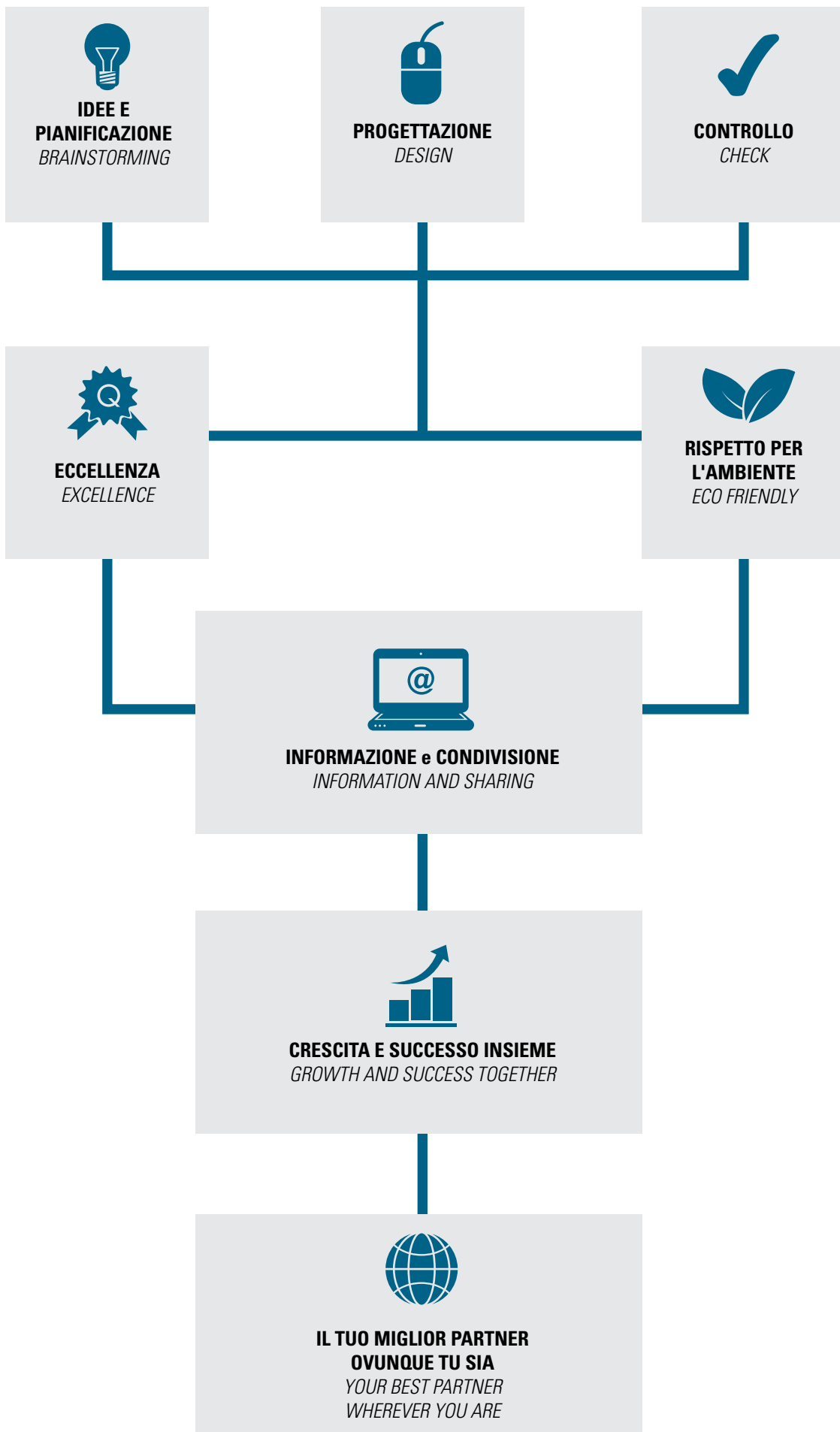

pag. 7

Profili per rivestimenti

Profiles for wall covering



pag. 23

Profili per pavimenti

Profiles for Floors



pag. 37

Profili per gradini

Stair nosing profiles



pag. 39

Battiscopa Skirting boards

pag. 41

Profili di raccordo igienici Hygienic cove Profiles



pag. 47

Profili per balconi e terrazzi

Edging Profiles for terraces and balconies



pag. 55

Sistemi di drenaggio

Draining and shower systems



pag. 63

Giunti di dilatazione, Accessori per la posa

Accessories for laying movement joints



pag. 69

Profili per il fai da te DIY Profiles

Alluminio/Aluminium

pag. 89 Acciaio/Steel

pag. 93 Ferro/Iron

pag. 99 Lamiera/Sheets



pag. 105

Sistemi espositivi e proposte di Vendita

Display systems and sales proposals



pag. 116

Imballi-Etichette-Materiali-Condizioni di vendita

Packing-Labels-Materials-Terms of sale



SPECIAL
PROFILES

Profili per Rivestimenti

Profile for wall covering

**ALLUMINIO
ANODIZZATO ARGENTO**
 Silver Anodized Aluminium

SPECIAL ROUND AL

Spessore Thickness T	Dimensioni Size H	Lunghezza Length		Satinato Anodized AAA	Brillante Bright ABA	Spazzolato* Brushed ASA	Q.tà conf. Pcs. box
mm	mm	m	Cod. Art./Item Code	€/pz	€/pz	€/pz	pz/pcs

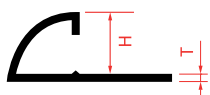
ALLUMINIO ALUMINIUM

ESTRUSO / EXTRUDED

1	6	2,7	SPRO00061AAA27				10
			SPRO00061ABA27				
			SPRO00061ASA27				
	8		SPRO00081AAA27				
			SPRO00081ABA27				
			SPRO00081ASA27				
	10		SPRO00101AAA27				
			SPRO00101ABA27				
			SPRO00101ASA27				
	12,5		SPRO00121AAA27				
			SPRO00121ABA27				
			SPRO00121ASA27				

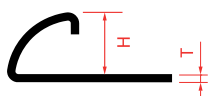

PROFILATO / PROFILED

0,7	8	2,7	SPRO00087AAA27				10
			SPRO00087ABA27				
	10		SPRO00107AAA27				
			SPRO00107ABA27				
	12,5		SPRO00127AAA27				
			SPRO00127ABA27				

**ALLUMINIO
ANODIZZATO ARGENTO**
 Silver Anodized Aluminium

SPECIAL CAPSR-AL

Dimensioni Size H		Satinato Anodized AAA	Brillante Bright ABA	Q.tà conf. Pcs. box
mm	Cod. Art./Item Code	€/pz	€/pz	

ALLUMINIO ALUMINIUM

8	SPCR0008AAA0A			10
	SPCR0008ABA0A			
10	SPCR0010AAA0A			
	SPCR0010ABA0A			
12	SPCR0012AAA0A			
	SPCR0012ABA0A			

* Note: Prodotto con disponibilità limitata. Verificare prima dell'ordine.

* Note: Product with limited availability. Check before ordering.

A = Tappo semplice / Simple cap

O-RING fornito per profilo spessore 0,7 mm / O-RING to use with profiles thickness 0,7 mm

**ALLUMINIO
ANODIZZATO NERO***
 Black Anodized Aluminium

	Spessore Thickness T	Dimensioni Size H	Lunghezza Length		Satinato Anodized AAN	Brillante Bright ABN	Spazzolato* Brushed ASN	Q.tà conf. Pcs. box
SPECIAL ROUND AL*	mm	mm	m	Cod. Art./Item Code	€/pz	€/pz	€/pz	pz/pcs

ALLUMINIO ALUMINIUM



ESTRUSO / EXTRUDED

1	6**	2,7	SPRO00061AAN27				10
			SPRO00061ABN27				
			SPRO00061ASN27				
	8		SPRO00081AAN27				
			SPRO00081ABN27				
			SPRO00081ASN27				
	10		SPRO00101AAN27				
			SPRO00101ABN27				
			SPRO00101ASN27				
	12,5		SPRO00121AAN27				
			SPRO00121ABN27				
			SPRO00121ASN27				

**ALLUMINIO
ANODIZZATO ORO***
 Gold Anodized Aluminium

	Spessore Thickness T	Dimensioni Size H	Lunghezza Length		Satinato Anodized AAO	Brillante Bright ABO	Q.tà conf. Pcs. box
SPECIAL ROUND AL*	mm	mm	m	Cod. Art./Item Code	€/pz	€/pz	pz/pcs

ALLUMINIO ALUMINIUM



ESTRUSO / EXTRUDED

1	6**	2,7	SPRO00061AAO27				10
			SPRO00061ABO27				
			SPRO00081AAO27				
	8		SPRO00081ABO27				
			SPRO00101AAO27				
			SPRO00101ABO27				
	10		SPRO00121AAO27				
			SPRO00121ABO27				
			SPRO00121ABO27				

* Note: Prodotto con disponibilità limitata. Verificare prima dell'ordine.

* Note: Product with limited availability. Check before ordering.

** Articolo a richiesta. Ordine minimo 100 pz

** Article on request. Minimum order 100 pcs

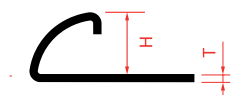

	Spessore Thickness T	Dimensioni Size H	Lunghezza Length		Acciaio Lucido Polished S-Steel	Acciaio Spazzolato Brushed S-Steel	Q.tà conf. Pcs. box
SPECIAL ROUND AC	mm	mm	m	Cod. Art./Item Code	€/pz	€/pz	pz/pcs

 ACCIAIO S-STEEL
AISI 304

0,7	8	2,7	SPRO00087IL27			10
			SPRO00087IS27			
	10		SPRO00107IL27			
			SPRO00107IS27			
	12,5		SPRO00127IL27			
			SPRO00127IS27			
	15		SPRO00157IL27			
			SPRO00157IS27			

SPECIAL CAPSR-AC

 ACCIAIO S-STEEL
AISI 304

	8		SPCR0008PVA0A			10
			SPCR0008PVS0A			
	10		SPCR0010PVA0A			
			SPCR0010PVS0A			
	12,5		SPCR0012PVA0A			
			SPCR0012PVS0A			

	Dimensioni Size H	Lunghezza Length		PVC bianco White PVC	Quantità Pcs. box
SPECIAL ROUND-PVC	mm	m	Cod. Art./Item Code	€/pz	pz/pcs

PVC PVC



6	2,60	SPRO0006PVB25		10
8		SPRO0008PVB25		
10		SPRO0010PVB25		
12		SPRO0012PVB25		

 Colori disponibili nella pagina seguente
 Other colours available on the next page

SPECIAL CAPSR-PVC	6		SPCR0006PB00		10
	8		SPCR0008PB00		
	10		SPCR0010PB00		
	12		SPCR0012PB00		

PVC PVC



	Dimensioni Size H	Lunghezza Length		PVC colorato Colored PVC		Quantità Pcs. box
SPECIAL ROUND-PVC	mm	m	Cod. Art./Item Code	colore/colour	€/pz	pz/pcs

PVC PVC



10	2,60	SPRO0010PVA26	Avorio/Ivory		10
		SPRO0010PVR26	Rosa/Pink		
		SPRO0010PVG26	Grigio/Grey		
		SPRO0010PVC26	Celeste/Light blue		





	Dimensioni Size H	Lunghezza Length		PVC marmorizzato marbled PVC		Quantità Packing
SPECIAL ROUND-PVC	mm	m	Cod. Art./Item Code	colore/colour	€/pz	pz/pcs

PVC PVC



10	2,6	SPRO0010PVMO26	Rosa/Pink		60
		SPRO0010PVMP26	Rosa pesca/Peach pink		
		SPRO0010PVMB26	Beige chiaro/Light beige		
		SPRO0010PVMS26	Beige sabbia/Sand beige		
		SPRO0010PVMT26	Beige tabacco/Tobacco beige		
		SPRO0010PVMV26	Travertino grigio/Travertine grey		
		SPRO0010PVME26	Crema/Yellow cream		
		SPRO0010PVMN26	Travertino beige/Travertine beige		
		SPRO0010PVMD26	Verde/Green		
		SPRO0010PVMZ26	Verde brazil/Brazil green		
		SPRO0010PVMI26	Grigio/ Grey		



ALLUMINIO
ANODIZZATO ARGENTO
 Silver Anodized Aluminium

	Spessore <i>Thickness</i> T	Dimensioni <i>Size</i> H	Lunghezza <i>Length</i> L		Satinato <i>Anodized</i> AAA	Brillante <i>Bright</i> ABA	Spazzolato* <i>Brushed</i> ASA	Q.tà conf. <i>Pcs. box</i>
SPECIAL SQUARE AL	mm	mm	m	Cod. Art./Item Code	€/pz	€/pz	€/pz	pz/pcs

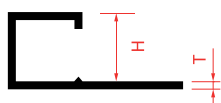
ALLUMINIO ALUMINIUM

ESTRUSO / EXTRUDED

1	4,5	2,7	SPSQ00451AAA27				10
			SPSQ00451ABA27				
			SPSQ00451ASA27				
	6		SPSQ00061AAA27				
			SPSQ00061ABA27				
			SPSQ00061ASA27				
	8		SPSQ00081AAA27				
			SPSQ00081ABA27				
			SPSQ00081ASA27				
	10		SPSQ00101AAA27				
			SPSQ00101ABA27				
			SPSQ00101ASA27				
12,5	SPSQ00121AAA27						
	SPSQ00121ABA27						
	SPSQ00121ASA27						

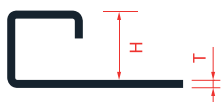

PROFILATO / PROFILED

mm	mm	m	Cod. Art./Item Code	€/pz	€/pz	pz/pcs	
0,7	8	2,7	SPSQ00087AAA27			10	
			SPSQ00087ABA27				
	10		SPSQ00107AAA27				
			SPSQ00107ABA27				
	12,5		SPSQ00127AAA27				
			SPSQ00127ABA27				

ALLUMINIO
ANODIZZATO ARGENTO
 Silver Anodized Aluminium

	Dimensioni <i>Size</i> H		Satinato <i>Anodized</i> AAA	Brillante <i>Bright</i> ABA	Q.tà conf. <i>Pcs. box</i>
SPECIAL CAPSQ-AL	mm	Cod. Art./Item Code	€/pz	€/pz	

ALLUMINIO ALUMINIUM

8	SPCQ0008AAA0A			10
	SPCQ0008ABA0A			
10	SPCQ0010AAA0A			10
	SPCQ0010ABA0A			
12	SPCQ0012AAA0A			10
	SPCQ0012ABA0A			

A = Tappo semplice / Simple cap

O-RING fornito per profilo spessore 0,7 mm / O-RING to use with profiles thickness 0,7 mm

* Note: Prodotto con disponibilità limitata. Verificare prima dell'ordine.

* Note: Product with limited availability. Check before ordering.

ALLUMINIO
ANODIZZATO NERO*
 Black Anodized Aluminium

	Spessore Thickness T	Dimensioni Size H	Lunghezza Length		Satinato Anodized AAN	Brillante Bright ABN	Spazzolato* Brushed ASN	Q.tà conf. Pcs. box
SPECIAL SQUARE AL*	mm	mm	m	Cod. Art./Item Code	€/pz	€/pz	€/pz	pz/pcs

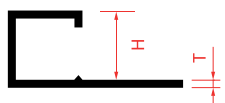
ALLUMINIO ALUMINIUM

ESTRUSO / EXTRUDED

1	4,5**	2,7	SPSQ00451AAN27				10
			SPSQ00451ABN27				
			SPSQ00451ASN27				
	6**		SPSQ00061AAN27				
			SPSQ00061ABN27				
			SPSQ00061ASN27				
	8		SPSQ00081AAN27				
			SPSQ00081ABN27				
	10		SPSQ00081ASN27				
			SPSQ00101AAN27				
	12,5		SPSQ00101ABN27				
			SPSQ00101ASN27				
SPSQ00121AAN27							
SPSQ00121ABN27							
			SPSQ00121ASN27				

ALLUMINIO
ANODIZZATO ORO*
 Gold Anodized Aluminium

	Spessore Thickness T	Dimensioni Size H	Lunghezza Length		Satinato Anodized AAO	Brillante Bright ABO	Q.tà conf. Pcs. box
SPECIAL SQUARE AL*	mm	mm	m	Cod. Art./Item Code	€/pz	€/pz	pz/pcs

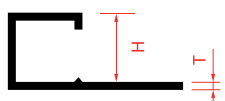
ALLUMINIO ALUMINIUM

ESTRUSO / EXTRUDED

1	4,5**	2,7	SPSQ00451AAO27			10
			SPSQ00451ABO27			
	6**		SPSQ00061AAO27			
			SPSQ00061ABO27			
	8**		SPSQ00081AAO27			
			SPSQ00081ABO27			
	10		SPSQ00101AAO27			
			SPSQ00101ABO27			
	12,5		SPSQ00121AAO27			
			SPSQ00121ABO27			

* Note: Prodotto con disponibilità limitata. Verificare prima dell'ordine.

* Note: Product with limited availability. Check before ordering.

** Articolo a richiesta. Ordine minimo 100 pz

** Article on request. Minimum order 100 pcs

ALLUMINIO VERNICIATO
EFFETTO PIETRA*
Stone effect painted
aluminum

	Spessore Thickness T	Dim. Size H	Lungh. Length		Anthracite Stone AGP	White Stone ABS	Beige Stone ABP	Black Stone ANS	Brown Stone AMS	Q.tà conf. Pcs. box
SPECIAL SQUARE AL	mm	mm	m	Cod. Art./Item Code	€/pz	€/pz	€/pz	€/pz	€/pz	pz/pcs

ALLUMINIO ALUMINIUM

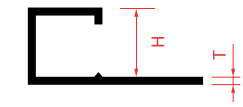

ESTRUSO / EXTRUDED

1	10	2,7	SPSQ00101AGP27						10
			SPSQ00101ABS27						
			SPSQ00101ABP27						
			SPSQ00101ANS27						
			SPSQ00101AMS27						
	12,5		SPSQ00121AGP27						
			SPSQ00121ABS27						
			SPSQ00121ABP27						
			SPSQ00121ANS27						
			SPSQ00121AMS27						

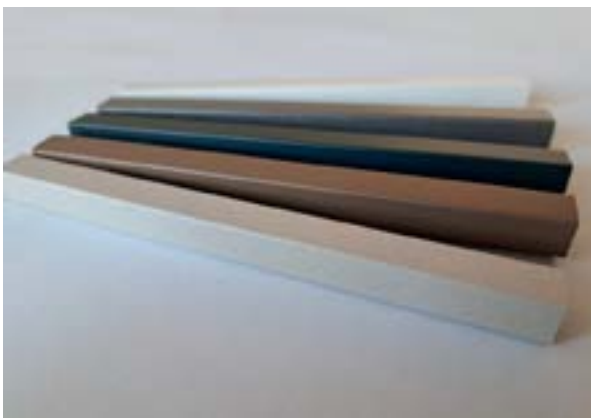

* Note: Prodotto con disponibilità limitata. Verificare prima dell'ordine.
* Note: Product with limited availability. Check before ordering.

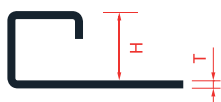

Spessore Thickness T	Dimensioni Size H	Lunghezza Length L		Acciaio Lucido Polished S-Steel	Acciaio Spazzolato Brushed S-Steel	Q.tà conf. Pcs. box	
SPECIAL SQUARE AC	mm	mm	m	Cod. Art./Item Code	€/pz	€/pz	pz/pcs

ACCIAIO S-STEEL
AISI 304

0,7	8	2,7	SPSQ00087IL27			10
			SPSQ00087IS27			
	10		SPSQ00107IL27			
			SPSQ00107IS27			
	11		SPSQ00117IL27			
			SPSQ00117IS27			
	12,5		SPSQ00127IL27			
			SPSQ00127IS27			

Dimensioni Size H		Acciaio Lucido Polished S-Steel	Acciaio Spazzolato Brushed S-Steel	Q.tà conf. Pcs. box	
SPECIAL CAPSQ-AC	mm	Cod. Art./Item Code	€/pz	€/pz	

ACCIAIO S-STEEL
AISI 304

8	SPCQ0008ILOA			10
	SPCQ0008IS0A			
10	SPCQ0010ILOA			
	SPCQ0010IS0A			
12	SPCQ0012ILOA			
	SPCQ0012IS0A			

Spessore Thickness T	Dimensioni Size H - L	Lunghezza Length L		Lucido* Polished	Spazzolato* Brushed	Q.tà conf. Pcs. box	
SPECIAL SQUARE AC ROVESCiato	mm	mm	m	Cod. Art./Item Code	€/pz	€/pz	pz/pcs

ACCIAIO S-STEEL
AISI 304

0,7	9	2,7	SPSQ0097IL27R			10
			SPSQ0097IS27R			
	11		SPSQ0117IL27R			
			SPSQ0117IS27R			
	12		SPSQ0127IL27R			
			SPSQ0127IS27R			

* Note: Prodotto con disponibilità limitata. Verificare prima dell'ordine.



* Note: Product with limited availability. Check before ordering.

A = Tappo semplice / Simple cap

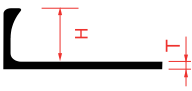

O-RING fornito per profilo spessore 0,7 mm / O-RING to use with profiles thickness 0,7 mm

NEW

**ALLUMINIO ANODIZZATO
ARGENTO***
 Argento Anodized Aluminium

	Spessore Thickness T	Dimensioni Size H	Lunghezza Length		Satinato Anodized AAA	Brillante Bright ABA	Spazzolato* Brushed ASA	Q.tà conf. Pcs. box
SPECIAL TERM-AL	mm	mm	m	Cod. Art./Item Code	€/pz	€/pz	€/pz	pz/pcs
ALLUMINIO ALUMINIUM								
 	1	4,5	2,7	SPTE0045AAA27				10
				SPTE0045ABA27				
				SPTE0045ASA27				
		6		SPTE0006AAA27				
				SPTE0006ABA27				
				SPTE0006ASA27				
		8		SPTE0008AAA27				
				SPTE0008ABA27				
				SPTE0008ASA27				
		10		SPTE0010AAA27				
				SPTE0010ABA27				
				SPTE0010ASA27				
		11		SPTE0011AAA27				
				SPTE0011ABA27				
				SPTE0011ASA27				
		12,5		SPTE0012AAA27				
				SPTE0012ABA27				
				SPTE0012ASA27				
15	SPTE0015AAA27							
	SPTE0015ABA27							
	SPTE0015ASA27							

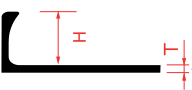
**ALLUMINIO
ANODIZZATO NERO***
 Black Anodized Aluminium

					AAN	ABN	ASN*	
SPECIAL TERM-AL	mm	mm	m	Cod. Art./Item Code	€/pz	€/pz	€/pz	pz/pcs
ALLUMINIO ALUMINIUM								
 	1	4,5**	2,7	SPTE0045AAN27				10
				SPTE0045ABN27				
				SPTE0045ASN27				
		6**		SPTE0006AAN27				
				SPTE0006ABN27				
				SPTE0006ASN27				
		8		SPTE0008AAN27				
				SPTE0008ABN27				
				SPTE0008ASN27				
		10		SPTE0010AAN27				
				SPTE0010ABN27				
				SPTE0010ASN27				
		12,5		SPTE0012AAN27				
				SPTE0012ABN27				
				SPTE0012ASN27				
		15**		SPTE0015AAN27				
				SPTE0015ABN27				
				SPTE0015ASN27				

** Articolo a richiesta. Ordine minimo 100 pz - ** Article on request. Minimum order 100 pcs

**ALLUMINIO
ANODIZZATO ORO***
 Gold Anodized Aluminium

SPECIAL TERM-AL

Spessore Thickness T	Dimensioni Size H	Lunghezza Length		Satinato Anodized AAO	Brillante Bright ABO	Q.tà conf. Pcs. box
mm	mm	m	Cod. Art./Item Code	€/pz	€/pz	pz/pcs

ALLUMINIO ALUMINIUM

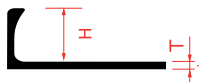

1	4,5**	2,7	SPTE0045AAO27			10
			SPTE0045ABO27			
	6**		SPTE0006AAO27			
			SPTE0006ABO27			
	8		SPTE0008AAO27			
			SPTE0008ABO27			
	10		SPTE0010AAO27			
			SPTE0010ABO27			
	12,5		SPTE0012AAO27			
			SPTE0012ABO27			
	15**		SPTE0015AAO27			
			SPTE0015ABO27			

**ALLUMINIO VERNICIATO
EFFETTO PIETRA**
 Stone effect painted
 aluminum

SPECIAL TERM-AL

Spessore Thickness T	Dim. Size H	Lungh. Length		Anthracite Stone AGP	White Stone ABS	Beige Stone ABP	Black Stone ANS	Brown Stone AMS	Q.tà conf. Pcs. box
mm	mm	m	Cod. Art./Item Code	€/pz	€/pz	€/pz	€/pz	€/pz	pz/pcs

ALLUMINIO ALUMINIUM

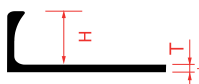

1	10	2,7	SPTE0010AGP27						10
			SPTE0010ABS27						
			SPTE0010ABP27						
			SPTE0010ANS27						
			SPTE0010AMS27						
	11		SPTE0011AGP27						
			SPTE0011ABS27						
			SPTE0011ABP27						
			SPTE0011ANS27						
			SPTE0011AMS27						
	12,5		SPTE0012AGP27						
			SPTE0012ABS27						
			SPTE0012ABP27						
			SPTE0012ANS27						
			SPTE0012AMS27						

* Note: Prodotto con disponibilità limitata. Verificare prima dell'ordine.

* Note: Product with limited availability. Check before ordering.

** Articolo a richiesta. Ordine minimo 100 pz - ** Article on request. Minimum order 100 pcs

SPECIALTERM-AC	Spessore Thickness T	Dimensioni Size H	Lunghezza Length		Acciaio Lucido Polished S-Steel	Acciaio Spazzolato Brushed S-Steel	Q.tà conf. Pcs. box
	mm	mm	m	Cod. Art./Item Code	€/pz	€/pz	pz/pcs

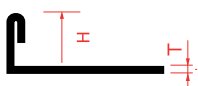
**ACCIAIO S-STEEL
AISI 304**

0,7	8	2,7	SPTE00087IL27			10
			SPTE00087IS27			
	10		SPTE00107IL27			
			SPTE00107IS27			
	11		SPTE00117IL27			
			SPTE00117IS27			
	12,5		SPTE00127IL27			
			SPTE00127IS27			
	15		SPTE00157IL27			
			SPTE00157IS27			
	20		SPTE00207IL27			
			SPTE00207IS27			
	25		SPTE00257IL27			
			SPTE00257IS27			
	30		SPTE00307IL27			
			SPTE00307IS27			

Spessore Thickness T	Dimensioni Size H	Lunghezza Length		Acciaio Lucido Polished S-Steel	Acciaio Spazzolato Brushed S-Steel	Q.tà conf. Pcs. box
mm	mm	m	Cod. Art./Item Code	€/pz	€/pz	pz/pcs

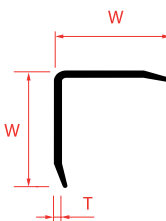
SPECIAL CORNER AC
**ACCIAIO S-STEEL
AISI 304**

0,7	15	2,7	SPCO15157IL27			10
			SPCO1515IS27			
	20		SPCO20207IL27			
			SPCO2020IS27			
	25		SPCO25257IL27			
			SPCO2525IS27			
30	SPCO30307IL27					
	SPCO30307IS27					





	Spessore <i>Thickness</i> T	Dimensioni <i>Size</i> W	Dimensioni <i>Size</i> H	Lunghezza <i>Length</i>		Acciaio Lucido <i>Polished S-Steel</i>	Q.tà conf. <i>Pcs. box</i>
SPECIAL CORNER POSA AC	mm	mm	mm	m	Cod. Art./Item Code	€/pz	pz/pcs

ACCIAIO *S-STEEL*
AISI 304

0,7	30	8	2,7	SPCS30307IL08	10
		10		SPCS30307IL10	
		12		SPCS30307IL12	

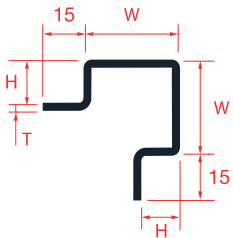

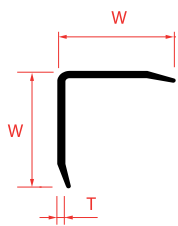
**ALLUMINIO
ANODIZZATO ARGENTO**
 Silver Anodized Aluminium

Spessore Thickness T	Dimensioni Size W	Lunghezza Length		Satinato Anodized	Brillante Bright	Spazzolato* Brushed	Q.tà conf. Pcs. box
-----------------------------------	--------------------------------	---------------------	--	----------------------	---------------------	------------------------	------------------------

SPECIAL CORNER AL	mm	mm	m	Cod. Art./Item Code	€/pz	€/pz	€/pz	pz/pcs
-------------------	----	----	---	---------------------	------	------	------	--------



1	25	3	SPCO25251AAA27				10
			SPCO25251ABA27				
			SPCO25251ASA27				

**ALLUMINIO
ANODIZZATO NERO***
 Black Anodized Aluminium

SPECIAL CORNER AL	mm	mm	m	Cod. Art./Item Code	€/pz	€/pz	€/pz	pz/pcs
-------------------	----	----	---	---------------------	------	------	------	--------



1	25	3	SPCO25251AAN27				10
			SPCO25251ABN27				
			SPCO25251ASN27				

**ALLUMINIO
ANODIZZATO ORO***
 Gold Anodized Aluminium

SPECIAL CORNER AL	mm	mm	m	Cod. Art./Item Code	€/pz	€/pz	pz/pcs
-------------------	----	----	---	---------------------	------	------	--------



1	25	3	SPCO25251AAO27			10
			SPCO25251ABO27			

** Articolo a richiesta con quantità e tempi da definire, disponibili anche nei seguenti colori:

** Item on on request with quantities and times to be defined before ordering. Available in the following colours:



AGP
Anthracite
Stone



ABS
White
Stone



ABP
Beige
Stone



ANS
Black
Stone



AMS
Brown
Stone

* Note: Prodotto con disponibilità limitata. Verificare prima dell'ordine.

* Note: Product with limited availability. Check before ordering.



Spessore Thickness T	Dimensioni Size W	Lunghezza Length		PVC bianco White PVC	PVC marrone Brown PVC	Q.tà conf. Pcs. box
mm	mm	m	Cod. Art./Item Code	€/pz	€/pz	pz/pcs

SPECIAL CORNER PVC

PVC PVC

1	28	3	SPCO2828PVB03			20
			SPCO2828PVM03			

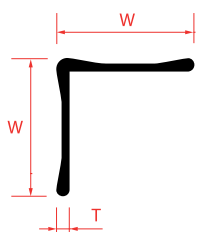

SPECIAL CORNER PVC

PVC PVC

mm	mm	m	Cod. Art./Item Code	€/pz	€/pz	pz/pcs
1	22	2,6	SPCO2222PVB26			110

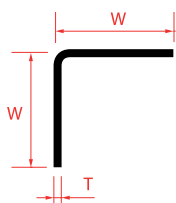



SPECIAL
PROFILES

Profili per Pavimenti
Profiles for Floors

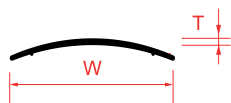

Spessore Thickness T	Dimensioni Size W	Lunghezza Length		Satinato Anodized	Brillante Bright	Spazzolato* Brushed	Q.tà conf. Pcs. box
-----------------------------------	--------------------------------	---------------------	--	----------------------	---------------------	------------------------	------------------------

SPECIAL SEMI-AL	mm	mm	m	Cod. Art./Item Code	€/pz	€/pz	€/pz	pz/pcs
-----------------	----	----	---	---------------------	------	------	------	--------

**ALLUMINIO
ANODIZZATO ARGENTO***
 Silver Anodized
 Aluminium

1	30	2,7	SPSE00301AAA27				10		
			SPSE00301ABA27						
			SPSE00301ASA27						
		<i>Con adesivo Self adhesive</i>							
		2,7	SPSE0030AAA27A						
			SPSE0030ABA27A						
			SPSE0030ASA27A						
		<i>Profili in blister Thermo packed profiles</i>							
		0,9	SPSE00301AAA09						
			SPSE00301ABA09						
			SPSE00301ASA09						
		<i>Blister con adesivo Self adhesive Thermo packed profiles</i>							
		0,9	SPSE0030AAA09A						
			SPSE0030ABA09A						
			SPSE0030ASA09A						

SPECIAL SEMI-AL	mm	mm	m	Cod. Art./Item Code	€/pz	€/pz	€/pz	pz/pcs
-----------------	----	----	---	---------------------	------	------	------	--------

**ALLUMINIO ANODIZZATO
NERO***
 Black Anodized
 Aluminium

1	30	2,7	SPSE00301AAN27				10		
			SPSE00301ABN27						
			SPSE00301ASN27						
		<i>Con adesivo Self adhesive</i>							
		2,7	SPSE0030AAN27A						
			SPSE0030ABN27A						
			SPSE0030ASN27A						
		<i>Profili in blister Thermo packed profiles</i>							
		0,9	SPSE0030AAN09A						
			SPSE0030ABN09A						
			SPSE0030ASN09A						
		<i>Blister con adesivo Self adhesive Thermo packed profiles</i>							
		0,9	SPSE0030AAN09A						
			SPSE0030ABN09A						
			SPSE0030ASN09A						

* Note: Prodotto con disponibilità limitata. Verificare prima dell'ordine.

* Note: Product with limited availability. Check before ordering.

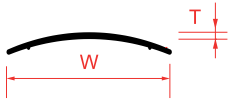

Spessore <i>Thickness</i> T	Dimensioni <i>Size</i> W	Lunghezza <i>Length</i>		Satinato <i>Anodized</i>	Brillante <i>Bright</i>	Q.tà conf. <i>Pcs. box</i>
--	---------------------------------------	----------------------------	--	-----------------------------	----------------------------	-------------------------------

SPECIAL SEMI-AL	mm	mm	m	Cod. Art./Item Code	€/pz	€/pz	pz/pcs
-----------------	----	----	---	---------------------	------	------	--------

**ALLUMINIO ANODIZZATO
ORO**
 Gold Anodized Aluminium

1	30	2,7	SPSE00301AAO27			10	
			SPSE00301ABO27				
		Con adesivo <i>Self adhesive</i>					
		2,7	SPSE0030AAO27A				
			SPSE0030ABO27A*				
		Profili in blister <i>Thermo packed profiles</i>					
		0,9	SPSE00301AAO09				
			SPSE00301ABO09				
		Blister con adesivo <i>Self adhesive Thermo packed profiles</i>					
		0,9	SPSE0030AAO09A				
			SPSE0030ABO09A				

* Note: Prodotto con disponibilità limitata. Verificare prima dell'ordine.

* Note: Product with limited availability. Check before ordering.

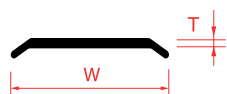

Spessore Thickness T	Dimensioni Size W	Lunghezza Length		Satinato Anodized	Brillante Bright	Spazzolato* Brushed	Q.tà conf. Pcs. box
----------------------------	-------------------------	---------------------	--	----------------------	---------------------	------------------------	------------------------

SPECIAL SEMIFLAT-AL	mm	mm	m	Cod. Art./Item Code	€/pz	€/pz	€/pz	pz/pcs
---------------------	----	----	---	---------------------	------	------	------	--------

**ALLUMINIO
ANODIZZATO ARGENTO***
Silver Anodized
Aluminium



1	25	2,7	SPSF00251AAA27				10		
			SPSF00251ABA27						
			SPSF00251ASA27						
		Con adesivo <i>Self adhesive</i>							
		2,7	SPSF0025AAA27A						
			SPSF0025ABA27A						
			SPSF0025ASA27A						
		Profili in blister <i>Thermo packed profiles</i>							
		0,9	SPSF00251AAA09						
			SPSF00251ABA09						
			SPSF00251ASA09						
		Blister con adesivo <i>Self adhesive Thermo packed profiles</i>							
		0,9	SPSF0025AAA09A						
			SPSF0025ABA09A						
			SPSF0025ASA09A						

SPECIAL SEMIFLAT-AL	mm	mm	m	Cod. Art./Item Code	€/pz	€/pz	€/pz	pz/pcs
---------------------	----	----	---	---------------------	------	------	------	--------

**ALLUMINIO ANODIZZATO
NERO***
Black Anodized
Aluminium



1	25	2,7	SPSF00251AAN27				10		
			SPSF00251ABN27						
			SPSF00251ASN27						
		Con adesivo <i>Self adhesive</i>							
		2,7	SPSF0025AAN27A						
			SPSF0025ABN27A						
			SPSF0025ASN27A						
		Profili in blister <i>Thermo packed profiles</i>							
		0,9	SPSF00251AAN09						
			SPSF00251ABN09						
			SPSF00251ASN09						
		Blister con adesivo <i>Self adhesive Thermo packed profiles</i>							
		0,9	SPSF0025AAN09A						
			SPSF0025ABN09A						
			SPSF0025ASN09A						

* Note: Prodotto con disponibilità limitata. Verificare prima dell'ordine.

* Note: Product with limited availability. Check before ordering.

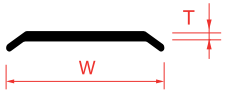

Spessore Thickness T	Dimensioni Size W	Lunghezza Length		Satinato Anodized	Brillante Bright	Q.tà conf. Pcs. box
-----------------------------------	--------------------------------	---------------------	--	----------------------	---------------------	------------------------

SPECIAL SEMIFLAT-AL

mm	mm	m	Cod. Art./Item Code	€/pz	€/pz	pz/pcs
----	----	---	---------------------	------	------	--------

**ALLUMINIO
ANODIZZATO ORO***
 Gold Anodized Aluminium

1	25	2,7	SPSF00251AAO27			10		
			SPSF00251ABO27					
		<i>Con adesivo Self adhesive</i>						
		2,7	SPSF0025AAO27A					
			SPSF0025ABO27A					
		<i>Profili in blister Thermo packed profiles</i>						
		0,9	SPSF00251AAO09					
			SPSF00251ABO09					
		<i>Blister con adesivo Self adhesive Thermo packed profiles</i>						
		0,9	SPSF0025AAO09A					
			SPSF0025ABO09A					

Spessore Thickness T	Dimensioni Size W - H	Lunghezza Length		Lucido Polished	Spazzolato* Brushed	Q.tà conf. Pcs. box
-----------------------------------	------------------------------------	---------------------	--	--------------------	------------------------	------------------------

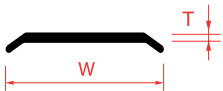
SPECIAL SEMI FLAT-AC
**ACCIAIO S-STEEL
AISI 304**

0,7	25	2,7	SPSF002571L27			10		
			SPSF002571S27					
		<i>Con adesivo Self adhesive</i>						
		2,7	SPSF00251L27A					
			SPSF00251S27A					
		<i>Profili in blister Thermo packed profiles</i>						
		0,9	SPSF002571L09					
			SPSF002571S09					
		<i>Blister con adesivo Self adhesive Thermo packed profiles</i>						
		0,9	SPSF00251L09A					
			SPSF00251S09A					

* Note: Prodotto con disponibilità limitata. Verificare prima dell'ordine.

* Note: Product with limited availability. Check before ordering.

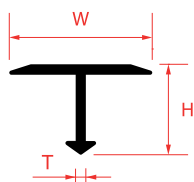

Spessore Thickness T	Dimensioni Size W	Lunghezza Length		Satinato Anodized	Brillante Bright	Spazzolato* Brushed	Q.tà conf. Pcs. box
-----------------------------------	--------------------------------	---------------------	--	----------------------	---------------------	------------------------	------------------------

SPECIALTI-AL	mm	mm	m	Cod. Art./Item Code	€/pz	€/pz	€/pz	pz/pcs
--------------	----	----	---	---------------------	------	------	------	--------

**ALLUMINIO
ANODIZZATO ARGENTO***
Silver Anodized
Aluminium



1	14x9	2,7	SPTI1409AAA27				10	
			SPTI1409ABA27					
			SPTI1409ASA27					
			SPTI2009AAA27					
			SPTI2009ABA27					
			SPTI2009ASA27					
	Profili in blister <i>Thermo packed profiles</i>							
	20x9	0,9	SPTI1409AAA09					
			SPTI1409ABA09					
			SPTI1409ASA09					
			SPTI2009AAA09					
			SPTI2009ABA09					
SPTI2009ASA09								

SPECIALTI-AL

**ALLUMINIO ANODIZZATO
NERO***
Black Anodized
Aluminium



1	14x9	2,7	SPTI1409AAN27				10	
			SPTI1409ABN27					
			SPTI1409ASN27					
			SPTI2009AAN27					
			SPTI2009ABN27					
			SPTI2009ASN27					
	Profili in blister <i>Thermo packed profiles</i>							
	20x9	0,9	SPTI1409AAN09					
			SPTI1409ABN09					
			SPTI1409ASN09					
			SPTI2009AAN09					
			SPTI2009ABN09					
SPTI2009ASN09								

* Note: Prodotto con disponibilità limitata. Verificare prima dell'ordine.

* Note: Product with limited availability. Check before ordering.

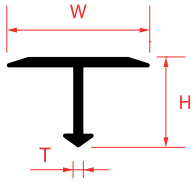

Spessore Thickness T	Dimensioni Size W	Lunghezza Length		Satinato Anodized AAO	Brillante Bright ABO	Q.tà conf. Pcs. box
-----------------------------------	--------------------------------	---------------------	--	------------------------------------	-----------------------------------	------------------------

SPECIAL TI-AL	mm	mm	m	Cod. Art./Item Code	€/pz	€/pz	pz/pcs
---------------	----	----	---	---------------------	------	------	--------

**ALLUMINIO
ANODIZZATO ORO***
 Gold Anodized Aluminium



1	14x9	2,7	SPTI1409AAO27			10	
			SPTI1409ABO27				
			20x9	SPTI2009AAO27			
				SPTI2009ABO27			
	Profili in blister <i>Thermo packed profiles</i>						
	14x9	0,9	SPTI1409AAO09				
			SPTI1409ABO09				
			20x9	SPTI2009AAO09			
SPTI2009ABO09							

Spessore Thickness T	Dimensioni Size W - H	Lunghezza Length		Lucido Polished	Spazzolato* Brushed	Q.tà conf. Pcs. box
-----------------------------------	------------------------------------	---------------------	--	--------------------	------------------------	------------------------

SPECIAL TI-AC	mm	mm	m	Cod. Art./Item Code	€/pz	€/pz	pz/pcs
---------------	----	----	---	---------------------	------	------	--------

**ACCIAIO S-STEEL
AISI 304**

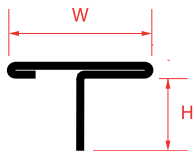
0,7	Profili in blister <i>Thermo packed profiles</i>					10
	20x8	0,9	SPTI20087ILO9			
			SPTI20087IS09			



* Note: Prodotto con disponibilità limitata. Verificare prima dell'ordine.
 * Note: Product with limited availability. Check before ordering.



Spessore Thickness T	Dimensioni Size W	Lunghezza Length		Satinato Anodized	Brillante Bright	Spazzolato* Brushed	Q.tà conf. Pcs. box
-----------------------------------	--------------------------------	---------------------	--	----------------------	---------------------	------------------------	------------------------

SPECIAL TILT-AL	mm	mm	m	Cod. Art./Item Code	€/pz	€/pz	€/pz	pz/pcs
-----------------	----	----	---	---------------------	------	------	------	--------

**ALLUMINIO
ANODIZZATO ARGENTO**
 Silver Anodized
 Aluminium

1	10	2,7	SPTL0010AAA27				10
			SPTL0010ABA27				
			SPTL0010ASA27				
	Profili in blister <i>Thermo packed profiles</i>						
10	0,9	0,9	SPTL0010AAA09				
			SPTL0010ABA09				
			SPTL0010ASA09				

**ALLUMINIO
ANODIZZATO NERO***
 Black Anodized
 Aluminium

1	10	2,7	SPTL0010AAN27				10
			SPTL0010ABN27				
			SPTL0010ASN27				
	Profili in blister <i>Thermo packed profiles</i>						
10	0,9	0,9	SPTL0010AAN09				
			SPTL0010ABN09				
			SPTL0010ASN09				

**ALLUMINIO
ANODIZZATO ORO***
 Gold Anodized Aluminium



1	10	2,7	SPTL0010AAO27				10
			SPTL0010ABO27				
			Profili in blister <i>Thermo packed profiles</i>				
	10	0,9	0,9	SPTL0010AAO09			
SPTL0010ABO09							

Spessore Thickness T	Dimensioni Size W	Lunghezza Length L		Naturale Natural	Satinato Silver	Q.tà conf. Pcs. box
-----------------------------------	--------------------------------	---------------------------------	--	---------------------	--------------------	------------------------

SPECIAL TILTBIG-AL	mm	mm	m	Cod. Art./Item Code	€/pz	€/pz	pz/pcs
--------------------	----	----	---	---------------------	------	------	--------

**ALLUMINIO
ANODIZZATO ARGENTO**
 Silver Anodized
 Aluminium

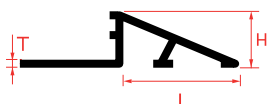
1,2	10	2,7	SPTLB0010ANA27			10
			SPTLB0010AAA27			
	12		SPTLB0012ANA27			
			SPTLB0012AAA27			



* Note: Prodotto con disponibilità limitata. Verificare prima dell'ordine.
 * Note: Product with limited availability. Check before ordering.

	Spessore Thickness T	Dimensioni Size W - H	Lunghezza Length		Lucido Polished	Spazzolato* Brushed	Q.tà conf. Pcs. box
SPECIAL TILT-AC	mm	mm	m	Cod. Art./Item Code	€/pz	€/pz	pz/pcs

**ACCIAIO S-STEEL
AISI 304**

0,7	10	2,7	SPTL001071L27			10
			SPTL001071S27			
	Profili in blister <i>Thermo packed profiles</i>					
	10	0,9	SPTL001071L09			
SPTL001071S09						

	Spessore Thickness T	Dimensioni Size W - H	Lunghezza Length		Lucido Polished	Spazzolato* Brushed	Q.tà conf. Pcs. box
SPECIAL TILT-AC	mm	mm	m	Cod. Art./Item Code	€/pz	€/pz	pz/pcs

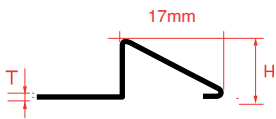
**ACCIAIO S-STEEL
AISI 304**

0,7	10	2,7	SPTL101871L27			10
			SPTL101871S27			

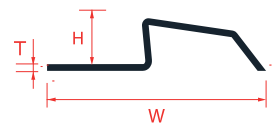

	mm	mm	m		€/pz	€/pz	pz/pcs
SPECIALTERMFLAT-AC				Cod. Art./Item Code			

**ACCIAIO S-STEEL
AISI 304**

0,7	55x10	2,7	SPTF001071L27			10
			SPTF001071S27			

* Note: Prodotto con disponibilità limitata. Verificare prima dell'ordine.
 * Note: Product with limited availability. Check before ordering.



Spessore Thickness T	Dimensioni Size W	Lunghezza Length		Satinato Anodized AAA	Brillante Bright ABA	Q.tà conf. Pcs. box
-----------------------------------	--------------------------------	---------------------	--	------------------------------------	-----------------------------------	------------------------

SPECIAL TERMTILT-AL	mm	mm	m	Cod. Art./Item Code	€/pz	€/pz	pz/pcs
---------------------	----	----	---	---------------------	------	------	--------

ALLUMINIO
ANODIZZATO ARGENTO
Silver Anodized
Aluminium



1	10	2,7	SPTT0010AAA27			10	
			SPTT0010ABA27				
	12		SPTT0012AAA27				
			SPTT0012ABA27				
	<i>Con adesivo Self adhesive</i>						
	10	2,7	SPTT0010AAA27A				
			SPTT0010ABA27A				
	12		SPTT0012AAA27A				
			SPTT0012ABA27A				
	<i>Profili in blister Blister profiles</i>						
	10	0,9	SPTT0010AAA09				
			SPTT0010ABA09				
	12		SPTT0012AAA09				
			SPTT0012ABA09				
	<i>Blister con adesivo Self adhesive Blister</i>						
	10	0,9	SPTT0010AAA09A				
	SPTT0010ABA09A						
12	SPTT0012AAA09A						
	SPTT0012ABA09A						



Spessore Thickness T	Dimensioni Size W	Lunghezza Length		Satinato Anodized AAN	Brillante Bright ABN	Q.tà conf. Pcs. box
-----------------------------------	--------------------------------	---------------------	--	------------------------------------	-----------------------------------	------------------------

SPECIAL TERMTILT-AL	mm	mm	m	Cod. Art./Item Code	€/pz	€/pz	pz/pcs
---------------------	----	----	---	---------------------	------	------	--------

**ALLUMINIO
ANODIZZATO NERO***
Black Anodized
Aluminium



1	10	2,7	SPTT0010AAN27			10	
			SPTT0010ABN27				
	12		SPTT0012AAN27				
			SPTT0012ABN27				
	<i>Con adesivo Self adhesive</i>						
	10	2,7	SPTT0010AAN27A				
			SPTT0010ABN27A				
	12		SPTT0012AAN27A				
			SPTT0012ABN27A				
	<i>Profili in blister Thermo packed profiles</i>						
	10	0,9	SPTT0010AAN09				
			SPTT0010ABN09				
	12		SPTT0012AAN09				
			SPTT0012ABN09				
	<i>Blister con adesivo Self adhesive Thermo packed profiles</i>						
	10	0,9	SPTT0010AAN09A				
	SPTT0010ABN09A						
12	SPTT0012AAN09A						
	SPTT0012ABN09A						

* Note: Prodotto con disponibilità limitata. Verificare prima dell'ordine.

* Note: Product with limited availability. Check before ordering.



Spessore <i>Thickness</i> T	Dimensioni <i>Size</i> W	Lunghezza <i>Length</i>		Satinato <i>Anodized</i> AAO	Brillante <i>Bright</i> ABO	Q.tà conf. <i>Pcs. box</i>
--	---------------------------------------	----------------------------	--	---	--	-------------------------------

SPECIAL TERMTILT-AL	mm	mm	m	Cod. Art./Item Code	€/pz	€/pz	pz/pcs
---------------------	----	----	---	---------------------	------	------	--------

**ALLUMINIO
ANODIZZATO ORO***
Gold Anodized Aluminium



1	10	2,7	SPTT0010AAO27			10	
			SPTT0010ABO27				
			SPTT0012AAO27				
			SPTT0012ABO27				
	<i>Con adesivo Self adhesive</i>						
	12	2,7	SPTT0010AAO27A				
			SPTT0010ABO27A				
			SPTT0012AAO27A				
			SPTT0012ABO27A				
	<i>Profili in blister Thermo packed profiles</i>						
	10	0,9	SPTT0010AAO09				
			SPTT0010ABO09				
			SPTT0012AAO09				
			SPTT0012ABO09				
	<i>Blister con adesivo Self adhesive Thermo packed profiles</i>						
	12	0,9	SPTT0010AAO09A				
SPTT0010ABO09A							
SPTT0012AAO09A							
SPTT0012ABO09A							

* Note: Prodotto con disponibilità limitata. Verificare prima dell'ordine.

* Note: Product with limited availability. Check before ordering.

	Spessore Thickness T	Dimensioni Size W - H	Lunghezza Length		Lucido Polished	Spazzolato* Brushed	Q.tà conf. Pcs. box
SPECIALTERMTILT-AC	mm	mm	m	Cod. Art./Item Code	€/pz	€/pz	pz/pcs

ACCIAIO S-STEEL
ISI 304

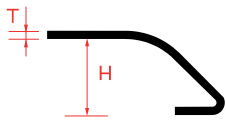

0,7	10	2,7	SPTT00107IL27			10	
			SPTT00107IS27				
			12	SPTT00127IL27			
				SPTT00127IS27			
	Con adesivo <i>Self adhesive</i>						
	10	2,7	SPTT00107IL27A				
			SPTT00107IS27A				
			12	SPTT00127IL27A			
				SPTT00127IS27A			
	Profili in blister <i>Thermo packed profiles</i>						
	10	0,9	SPTT00107IL09				
			SPTT00107IS09				
			12	SPTT00127IL09			
				SPTT00127IS09			
	Blister con adesivo <i>Self adhesive Thermo packed profiles</i>						
	10	0,9	SPTT00107IL09A				
SPTT00107IS09A							
12			SPTT00127IL09A				
			SPTT00127IS09A				

	Spessore Thickness T	Dimensioni Size H - L	Lunghezza Length		Lucido Polished	Spazzolato* Brushed	Q.tà conf. Pcs. box
SPECIAL SQUARE AC ROVESCiato	mm	mm	m	Cod. Art./Item Code	€/pz	€/pz	pz/pcs

ACCIAIO S-STEEL
AISI 304



0,7	9	2,7	SPSQ00097IL27R			10	
			SPSQ00097IS27R				
	11		SPSQ00097IL27R				
			SPSQ00097IS27R				
			12	SPSQ00097IL27R			
				SPSQ00097IS27R			



* Note: Prodotto con disponibilità limitata. Verificare prima dell'ordine.
* Note: Product with limited availability. Check before ordering.



Spessore Thickness T	Dimensioni Size W	Lunghezza Length		Naturale Natural ANA	Satinato Anodized AAA	Brillante* Bright ABA	Q.tà conf. Pcs. box
-----------------------------------	--------------------------------	---------------------	--	-----------------------------------	------------------------------------	------------------------------------	------------------------

SPECIAL BAND-AL	mm	mm	m	Cod. Art./Item Code	€/pz	€/pz	€/pz	pz/pcs
-----------------	----	----	---	---------------------	------	------	------	--------

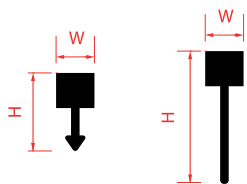
ALLUMINIO ALUMINIUM

	4,5X10	2,7	SPBA4510ANA27				10
			SPBA4510AAA27				
			SPBA4510ABA27				
	5X25		SPBA0525ANA27				
			SPBA0525AAA27				
			SPBA0525ABA27				

* Note: Prodotto con disponibilità limitata. Verificare prima dell'ordine.

* Note: Product with limited availability. Check before ordering.





SPECIAL
PROFILES

Profili per gradini

Stair nosing profiles

**PROFILI ALLUMINIO
ANODIZZATO ARGENTO**
 Silver Anodized
 Aluminium Profiles

Dimensioni Size WxH	Lunghezza Length		Satinato Anodized AAA	Brillante Bright ABA	Quantità per conf. Pcs. box
mm	m	Cod. Art./Item Code	€/pz	€/pz	pz/pcs

SPECIAL STEP-AL					
25x20	2,7	SPST2520AAA27			10
		SPST2520ABA27			
42x26		SPST4226AAA27			
SPST4226ABA27					

ALLUMINIO ALUMINIUM

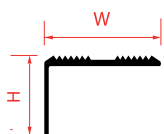

SPECIAL STEPSQ-AL					
20x10	2,7	SPSS0010AAA27			10
		SPSS0010ABA27			
20x12,5		SPSS0012AAA27			
		SPSS0012ABA27			

ALLUMINIO ALUMINIUM

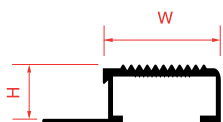

SPECIAL STEPROUND-AL					
10x10	2,7	SPSR0010AAA27			10
		SPSR0010ABA27			
10x12,5		SPSR0012AAA27			
		SPSR0012ABA27			

ALLUMINIO ALUMINIUM

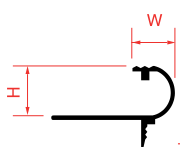



SPECIAL
PROFILES



Battiscopa
Skirting boards



AL

**SPECIAL
PROFILES**
Battiscopa
Skirting boards

**PROFILI ALLUMINIO
ANODIZZATO ARGENTO**
Silver Anodized
Aluminium Profiles

Spessore Thickness T	Dimensioni Size WxH	Lunghezza Length		Satinato Anodized AAA	Brillante Bright ABA	Q.tà conf. Pcs. box
mm	mm	m	Cod. Art./Item Code	€/pz	€/pz	pz/pcs

SPECIAL SKIRTING-AL

ALLUMINIO ALUMINIUM

1,5	10x60	2	SPSK0060AAA27			10
			SPSK0060ABA27			



AC

SPECIAL SKIRTING-AC*

 ACCIAIO S-STEEL
AISI 304

Spessore Thickness T	Dimensioni Size WxHxT	Lunghezza Length		Acciaio Lucido Polished S-Steel	Q.tà conf. Pcs. box
mm	mm	m	Cod. Art./Item Code	€/pz	pz/pcs

0,7	15x60	2	SPSK00607IL27		20
-----	-------	---	---------------	--	----

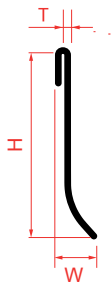
 * Altre misure su richiesta
* Other sizes on request

NEW



SPECIAL
PROFILES

Profili di raccordo igienici

Hygienic cove profiles

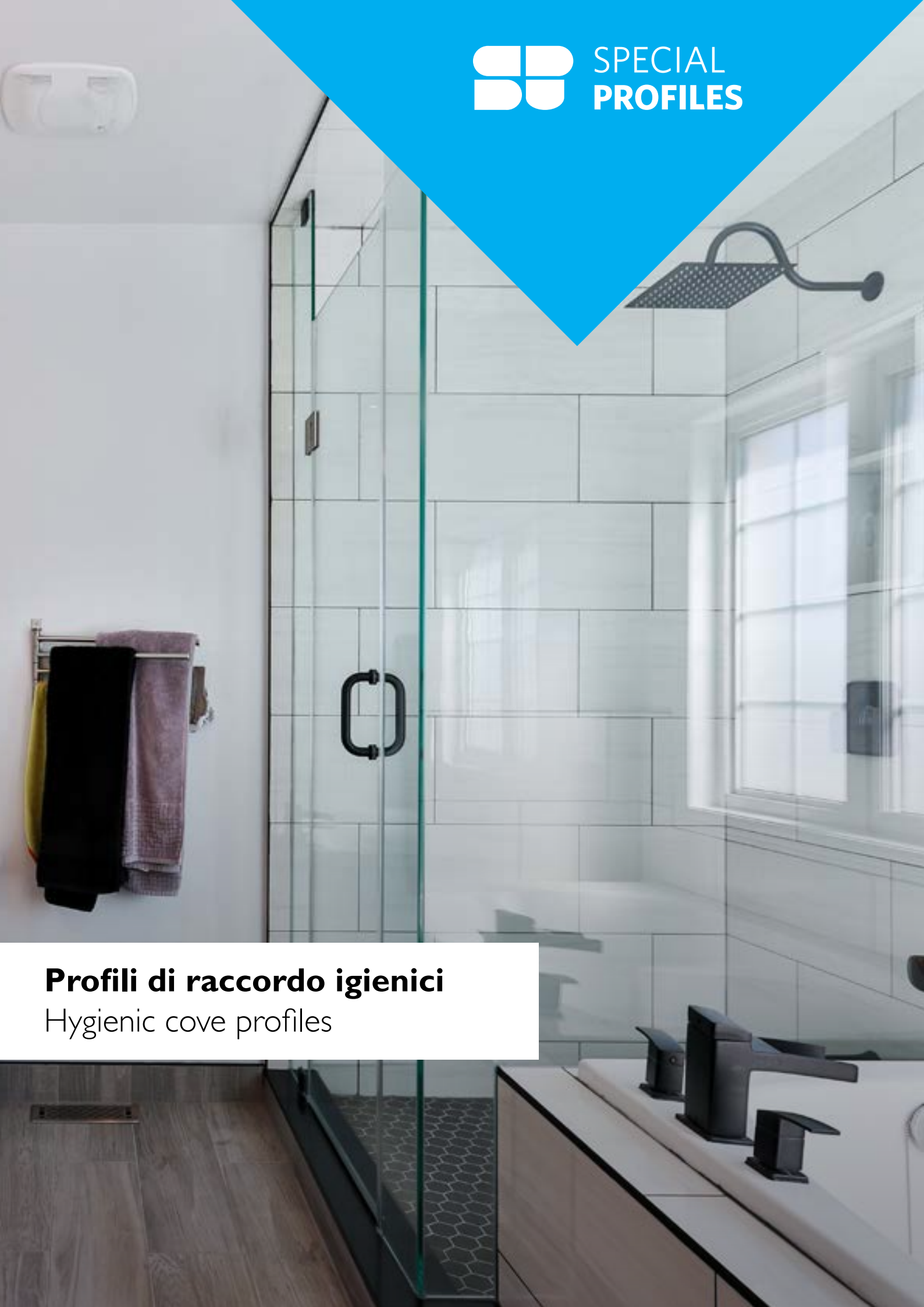



**PROFILI ALLUMINIO
ANODIZZATO ARGENTO**
 Silver Anodized
 Aluminium Profiles

Dimensioni <i>Size</i>	Lunghezza <i>Length</i>		Satinato Silver AAA	Brillante Bright Silver ABA	Quantità per conf. <i>Pcs. box</i>
mm	m	Cod. Art./Item Code	€/pz	€/pz	pz/pcs

SPECIAL SANIT-AL					
18x18	2,7	SPSA0020AAA27			10
		SPSA0020ABA27			

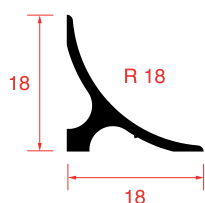
ALLUMINIO ALUMINIUM



SPECIAL PROTEC-AL	mm	m	Cod. Art./Item Code	€/pz	€/pz	pz/pcs
-------------------	----	---	---------------------	------	------	--------

ALLUMINIO ALUMINIUM

10x10	2,7	SPPR0010AAA27			10
		SPPR0010ABA27			

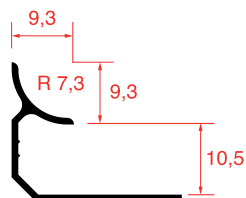

	Dimensioni Size H	Lunghezza Length		PVC bianco White PVC	Quantità per conf. Pcs. box
SPECIAL SANIT-PVC	mm	m	Cod. Art./Item Code	€/pz	pz/pcs

PVC PVC

45	2	SPSA4545PVB2		10
----	---	--------------	--	----

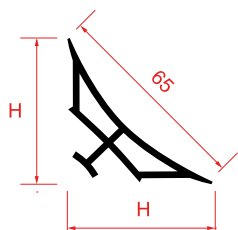

SPECIALSANIT ANG-INT	45		SPSA4545PVIN		10
-----------------------------	----	--	--------------	--	----

PVC PVC



SPECIALSANIT ANG-EST	45		SPSA4545PVES		10
-----------------------------	----	--	--------------	--	----

PVC PVC



SPECIAL PROTEC-PVC	8	2,6	SPPR0008PVB26		20
	10	2,6	SPPR0010PVB26		

PVC PVC

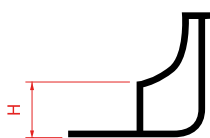

SPECIAL CAPPI-PVC	8		SPPI0008PB00		10
	10		SPPI0010PB01		

PVC PVC



SPECIAL CAPPE-PVC	8		SPPE0008PB00		10
	10		SPPE0010PB01		

PVC PVC



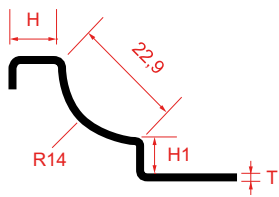

	Spessore Thickness T	Dimensioni Size H - H1	Lunghezza Length		Lucido Polished Steel	Spazzolato* Brushed	Quantità per conf. Pcs. box
SPECIAL PROTEC-AC	mm	mm	m	Cod. Art./Item Code	€/pz	€/pz	pz/pcs

 ACCIAIO AISI 304
 STEEL AISI 304

0,7	08x08	2,7	SPSG08087IL27			10
			SPSG08087IS27			
	10x10		SPSG10107IL27			
			SPSG10107IS27			
	10x12,5		SPSG10127IL27			
			SPSG10127IS27			



* Note: Prodotto con disponibilità limitata. Verificare prima dell'ordine.

* Note: Product with limited availability. Check before ordering.

	Dimensioni Size H	Lunghezza Length		PVC bianco White PVC	Quantità per conf. Pcs. box
SPECIAL SANIT-PVC	mm	m	Cod. Art./Item Code	€/pz	pz/pcs
PVC PVC	20	2,5	SPSA2020PVB25		20

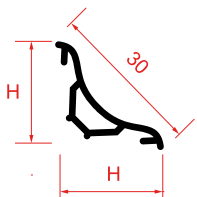

SPECIAL CAPSI-PVC	20x20		SPCI2020PB00		10
--------------------------	-------	--	--------------	--	----

PVC PVC



SPECIAL CAPSE-PVC	20x20		SPCE2020PB00		10
--------------------------	-------	--	--------------	--	----

PVC PVC



SPECIAL SANIT-PVC	20x20		SPTR2020PB00		10
--------------------------	-------	--	--------------	--	----

PVC PVC





SPECIAL
PROFILES

Profili per Balconi e Terrazzi

Edging Profiles for Balconies and Terraces

SPECIAL BORD-AL	Dimensioni Size	Lunghezza Length	Cod. Art./Item Code	Naturale Natural ANA	Anodizzati Anodized	Profili Verniciati Ral Ral Painted Profiles				Quantità per conf. Pcs. box
					Argento Silver AAA	Bianco White 9010	Grigio Grey 7038	Beige Light Brown 1019	Marrone Brown 8019	

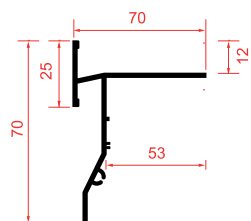
ALLUMINIO ALUMINIUM

70x70x12	2,7	SPSB0012ANA27								10
		SPSB0012AAA27								
		SPSB0012AVB27								
		SPSB0012AVG27								
		SPSB0012AVE27								
		SPSB0012AVM27								

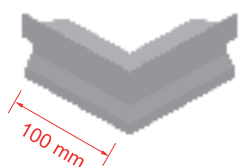
SPECIAL BORDCORN-AL
ALLUMINIO ALUMINIUM

100x45°	0,1	SPSC0012ANA10								5
		SPSC0012AAA10								
		SPSC0012AVB10								
		SPSC0012AVG10								
		SPSC0012AVE10								
		SPSC0012AVM10								

2 angoli già assemblati, da 100 mm, taglio 45°. 2 corners, 100 mm each, 45°, pre mounted.

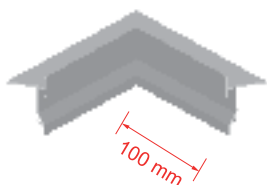
SPECIAL BORDANG-AL
ALLUMINIO ALUMINIUM

100x45°	0,1	SPSD0012ANA10								5
		SPSD0012AAA10								
		SPSD0012AVB10								
		SPSD0012AVG10								
		SPSD0012AVE10								
		SPSD0012AVM10								

2 angoli già assemblati, da 100 mm, taglio 45°. 2 corners, 100 mm each, 45°, pre mounted.

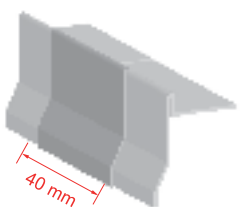
SPECIAL BORDFLATCONN-AL
ALLUMINIO ALUMINIUM

40	0,04	SPBN0001ANA04								50
		SPBN0001AAA04								
		SPBN0001AVB04								
		SPBN0001AVG04								
		SPBN0001AVE04								
		SPBN0001AVM04								

Dimensioni Size		Acciaio Lucido Polished S-Steel	Quantità per conf. Packing Quantity
mm	Cod. Art./Item Code	€/per conf.	pz/pcs

SPECIAL BORDPIN-AC
ACCIAIO S-STEEL

200xø4	SPSP0004IL20		50
--------	--------------	--	----

Pin di connessione. Connection's Pin



NEW

SpecialBord	Dimensioni Size	Lunghezza Length		Anthracite Stone AGP	Bianco White Stone ABS	Beige Stone ABP	Q.tà conf. Pcs. box
	mm	m	Cod. Art./Item Code	€/pz	€/pz	€/pz	pz/pcs

ALLUMINIO ALUMINIUM

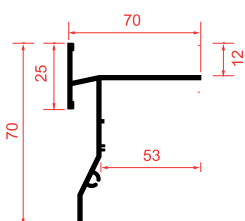

70x70x12	2,7	SPSB0012AGP27				10
		SPSB0012ABS27				
		SPSB0012ABP27				

SpecialBordCorn-AL

ALLUMINIO ALUMINIUM

100x45°

0,1

SPSC0012AGP12

SPSC0012ABS12

SPSC0012ABP12

5

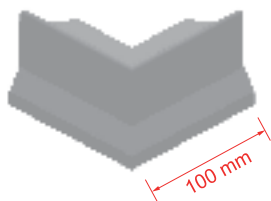

SpecialBordAng-AL

ALLUMINIO ALUMINIUM

100x45°

0,1

SPSD0012AGP12

SPSD0012ABS12

SPSD0012ABP12

5

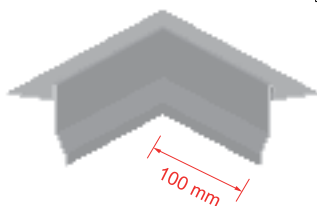

SpecialBordConn-AL

ALLUMINIO ALUMINIUM

40x70x12

0,1

SPBN0012AGP04

SPBN0012ABS04

SPBN0012ABP04

50

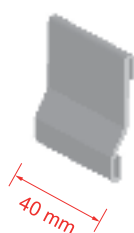

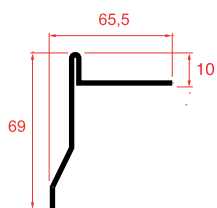

SpecialBordFlat-AL	Dimensioni Size	Lunghezza Length	Cod. Art./Item Code	Anodizzati Argento Silver Anodized	Profili Verniciati Ral Ral Painted Profiles				Quantità per conf. Pcs. box
				Satinato Silver AAA	Bianco White AVB	Grigio Grey AVG	Beige Light Brown AVE	Marrone Brown AVM	

ALLUMINIO ALUMINIUM

65,5x69x10	2,0	SPSF0010AAA27						10
		SPSF0010AVB27						
		SPSF0010AVG27						
		SPSF0010AVE27						
		SPSF0010AVM27						

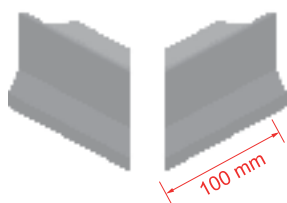
SpecialBordFlatCorn-AL *
ALLUMINIO ALUMINIUM

100x45°	0,1	SPBC0010AAA10						5
		SPBC0010AVB10						
		SPBC0010AVG10						
		SPBC0010AVE10						
		SPBC0010AVM10						

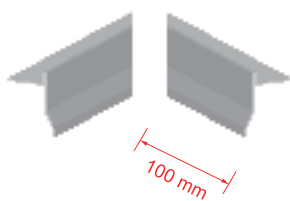
SpecialBordFlatAng-AL *
ALLUMINIO ALUMINIUM

100x45°	0,1	SPBG0010AAA10						5
		SPBG0010AVB10						
		SPBG0010AVG10						
		SPBG0010AVE10						
		SPBG0010AVM10						

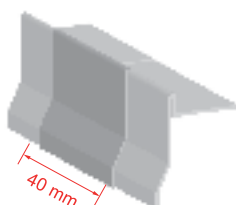
SpecialBordFlatConn-AL
ALLUMINIO ALUMINIUM

40	0,04	SPBN0010AAA04						50
		SPBN0010AVB04						
		SPBN0010AVG04						
		SPBN0010AVE04						
		SPBN0010AVM04						

* ATTENZIONE: Gli angoli sono forniti in due pezzi separati
 * PLEASE NOTE: Corners are supplied in two separate pieces

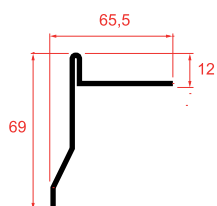

SpecialBordFlat-AL	Dimensioni Size	Lunghezza Length	Cod. Art./Item Code	Anodizzati Argento Silver Anodized	Profili Verniciati Ral Ral Painted Profiles				Quantità per conf. Pcs. box
				Satinato Silver AAA	Bianco White 9010	Grigio Grey 7038	Beige Light Brown 1019	Marrone Brown 8019	

ALLUMINIO ALUMINIUM

65,5x69x12	2,0	SPSF0012AAA27							10
		SPSF0012AVB27							
		SPSF0012AVG27							
		SPSF0012AVE27							
		SPSF0012AVM27							

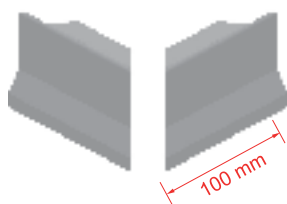
SpecialBordFlatCorn-AL *
ALLUMINIO ALUMINIUM

100x45°	0,1	SPBC0007AAA10						5
		SPBC0007AVB10						
		SPBC0007AVG10						
		SPBC0007AVE10						
		SPBC0007AVM10						

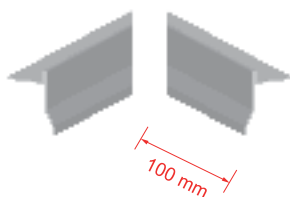
SpecialBordFlatAng-AL *
ALLUMINIO ALUMINIUM

100x45°	0,1	SPBG0007AAA10						5
		SPBG0007AVB10						
		SPBG0007AVG10						
		SPBG0007AVE10						
		SPBG0007AVM10						

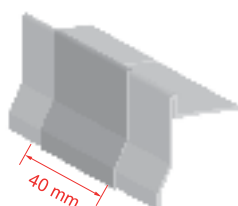
SPECIAL BORDFLATCONN-AL
ALLUMINIO ALUMINIUM

40	0,04	SPBN0007AAA04						50
		SPBN0007AVB04						
		SPBN0007AVG04						
		SPBN0007AVE04						
		SPBN0007AVM04						

* ATTENZIONE: Gli angoli sono forniti in due pezzi non saldati
 * PLEASE NOTE: Corners are supplied in two pieces not welded

NEW

	Dimensioni Size	Lunghezza Length		Anthracite Stone AGP	Bianco White Stone ABS	Beige Stone ABP	Q.tà conf. Pcs. box
SpecialBordFlat-AL	mm	m	Cod. Art./Item Code	€/pz	€/pz	€/pz	pz/pcs

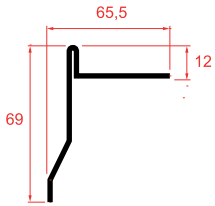
ALLUMINIO ALUMINIUM

65,5x69x10	2,0	SPSF0010AGP27				10
		SPSF0010ABS27				
		SPSF0010ABP27				
65,5x69x12		SPSF0012AGP27				
SPSF0012ABS27						
SPSF0012ABP27						

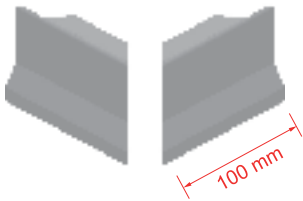
SpecialBordFlatCorn-AL *
ALLUMINIO ALUMINIUM

100x45°h10	0,1	SPBC0010AGP10				5
		SPBC0010ABS10				
		SPBC0010ABP10				
100x45°h12		SPBC0007AGP10				
		SPBC0007ABS10				
		SPBC0007ABP10				

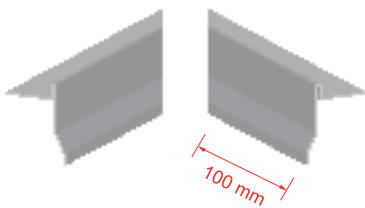
SpecialBordFlatAng-AC *
ALLUMINIO ALUMINIUM

100x45°h10	0,1	SPBG0010AGP10				5
		SPBG0010ABS10				
		SPBG0010ABP10				
100x45°h12		SPBG0007AGP10				
		SPBG0007ABS10				
		SPBG0007ABP10				

SpecialBordFlatConn-AC
ALLUMINIO ALUMINIUM

49x69xh10	0,1	SPBN0010AGP04				50
		SPBN0010ABS04				
		SPBN0010ABP04				
49x69xh12		SPBN0007AGP04				
		SPBN0007ABP04				
		SPBN0007ABP04				

* ATTENZIONE: Gli angoli sono forniti in due pezzi separati

* PLEASE NOTE: Corners are supplied in two separate pieces



	Dimensioni Size	Lunghezza Length		Acciaio Lucido Polished S-Steel	Q.tà conf. Pcs. box
SpecialBordFlat-AC	mm	m	Cod. Art./Item Code	€/pz	pz/pcs

ACCIAIO S-STEEL
AISI 304

65,5x69x12	2,7	SPBF0007IL027		10
------------	-----	---------------	--	----

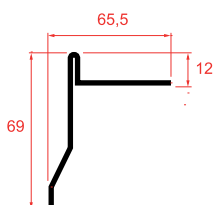

SpecialBordFlatCorn-AC *

100x45°	0,1	SPBC0007IL10		5
---------	-----	--------------	--	---

ACCIAIO S-STEEL
AISI 304

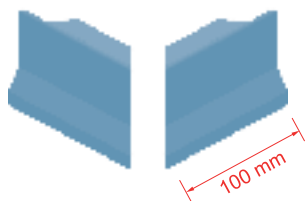

SpecialBordFlatAng-AC *

100x45°	0,1	SPBG0007IL04		5
---------	-----	--------------	--	---

ACCIAIO S-STEEL
AISI 304

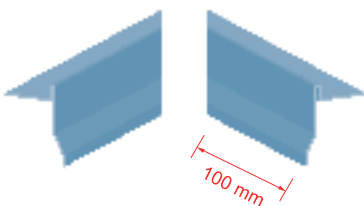

SpecialBordFlatConn-AC

40	0,4	SPBN0007IL04		50
----	-----	--------------	--	----

ACCIAIO S-STEEL
AISI 304

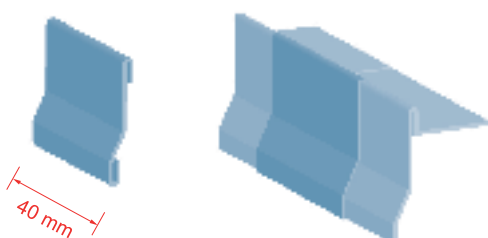

* ATTENZIONE: Gli angoli sono forniti in due pezzi separati
* PLEASE NOTE: Corners are supplied in two separate pieces



SPECIAL
PROFILES

Profili per il bagno

Draining and shower systems

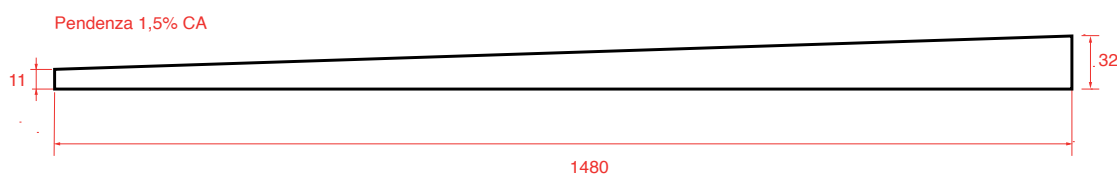
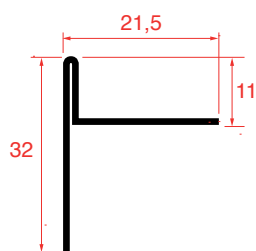

SPECIAL DRAIN

ACCIAIO S-STEEL
AISI 304

Dimensioni Size		Finitura	Lunghezza	Installazione	
mm	Cod. Art./Item Code		cm		€/pz



32x21x10,3	SPCP3207IS148D	Spazzolato	148	destra	
32x21x10,3	SPCP3207IS148S	Spazzolato	148	sinistra	
32x21x10,3	SPCP3207IL148S	Lucido	148	sinistra	
32x21x10,3	SPCP3207IL148D	Lucido	148	destra	



Profilo mono-pendenza in acciaio inox (AISI 304) per il pavimento in pendenza della doccia all'italiana. Copre perfettamente la parte inclinata(2%) non piastrellata ed evita il verificarsi di infiltrazioni. Non è più necessario tagliare le piastrelle a misura per coprire la parte inclinata non piastrellata . Disponibile per il lato destro e sinistro. Attenzione: per accorciare il profilo, tagliarlo nel punto più alto. Istruzioni per la pulizia: non pulire mai l'acciaio inox con materiali abrasivi ed i detersivi non devono contenere cloro o acido cloridrico.

Inclined-wedge in stainless steel (AISI 304) for the shower sloping floor. It perfectly covers the non-tiled sloping part (2%) and prevents infiltrations. It is no longer necessary to cut the tiles to size to cover the non-tiled sloping part. Available for left and right side.

Attention: to shorten the profile, cut it at the highest point.

Cleaning instructions: never clean stainless steel with abrasive materials and detergents must not contain chlorine or hydrochloric acid

SPECIAL DRAIN	Dimensioni Size mm	Cod. Art./Item Code	€/pz	Quantità per conf. Pcs. box pz/pcs
---------------	--------------------------	---------------------	------	--

ACCIAIO S-STEEL

100x100	SPCD1010IL00		16
---------	--------------	--	----

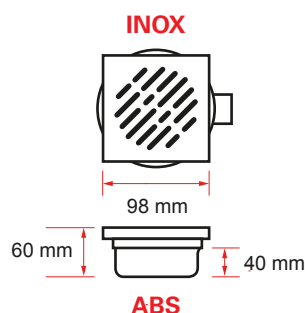

CHIUSINO 10X10 REGOLABILE CON GRIGLIA INOX
Corpo e sifone in ABS, Griglia in acciaio inox.

ADJUSTABLE 10x10 FLOOR DRAIN WITH INOX GRATING
Body and siphon in ABS - Grating in stainless steel Aisi 304



SPECIAL DRAIN

ACCIAIO S-STEEL

130x130	SPCD1313IL00		12
---------	--------------	--	----

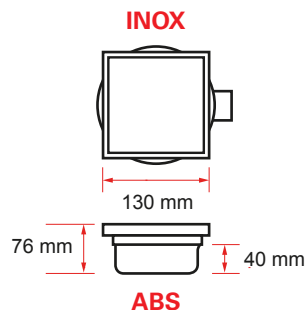

CHIUSINO REGOLABILE CON PORTAPIASTRELLA INOX
Acciaio 130x130
ADJUSTABLE INOX FLOOR DRAIN
with tile tray 130x130



SPECIAL DRAIN

ABS ABS

130x130	SPCD1313PV00		20
---------	--------------	--	----

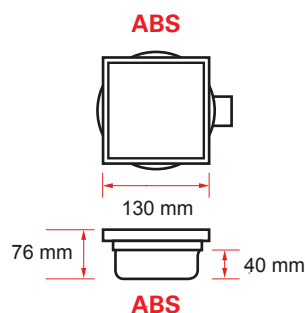

CHIUSINO REGOLABILE CON PORTAPIASTRELLA ABS
ABS 130x130
ADJUSTABLE ABS FLOOR DRAIN
with tile tray 130x130



Dimensioni Size	Portata Water flow			Quantità per conf. Pcs. box
mm	lpm	Cod. Art./Item Code	€/pz	pz/pcs
SPECIAL DRAIN ACCIAIO S-STEEL	100x100	200	SPCD1010ILOG	1

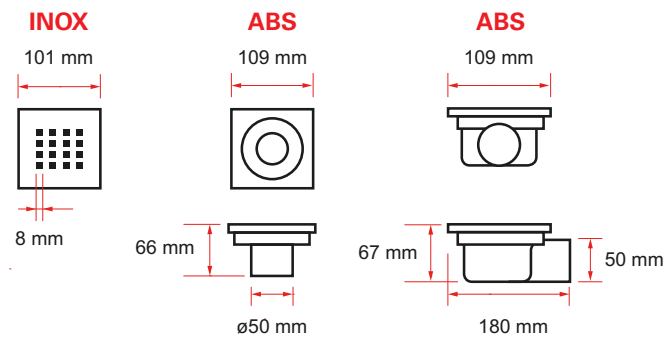

CHIUSINO 10x10 PER DOCCIA INOX

Griglia 16 fori, vaschetta e corpo sifonato

SHOWER DRAIN 10x10 INOX

16 holes grid, drain body and siphon body

Il Kit comprende il corpo sifonato, il foglio di guaina impermeabilizzante con adattatore incorporato, la vaschetta, il filtro e la griglia.

Materiale:

- Vaschetta in PVC
- Corpo sifonato e filtro in ABS
- Griglia e cornice della vaschetta in Acciaio INOX

The kit includes the siphon body, the waterproofing sheet with builtin adapter, the drain body, the filter and the grid.

Material:

Drain body, adapter and filter in ABS.

Grid and body frame in stainless steel AISI 304.

Waterproofing sheet composed of two external layers of polypropylene + an inner layer of polyethylene.



Chiavetta per la rimozione della grogna inclusa
Key for removing the grille included

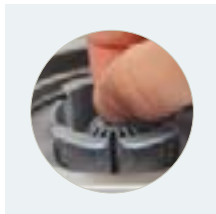

Filtro rimovibile
Removable filter



Uscita ø50
Ø50 outlet

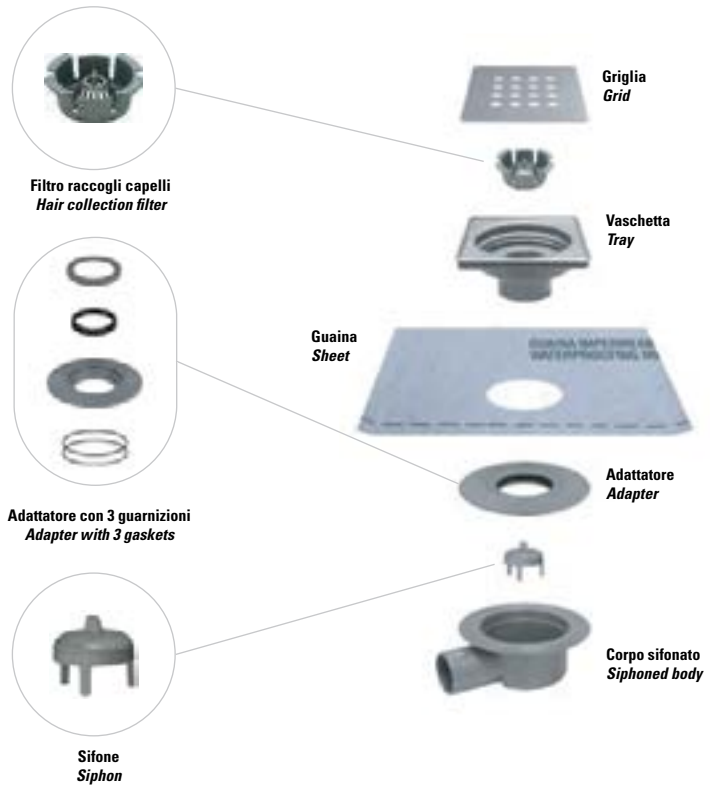

Dimensioni Size	Portata Water flow			Quantità per conf. Pcs. box
mm	lpm	Cod. Art./Item Code	€/pz	pz/pcs

SPECIAL LINEARG				
ACCIAIO S-STEEL	656x52	200	SPCL0065ILOG	1

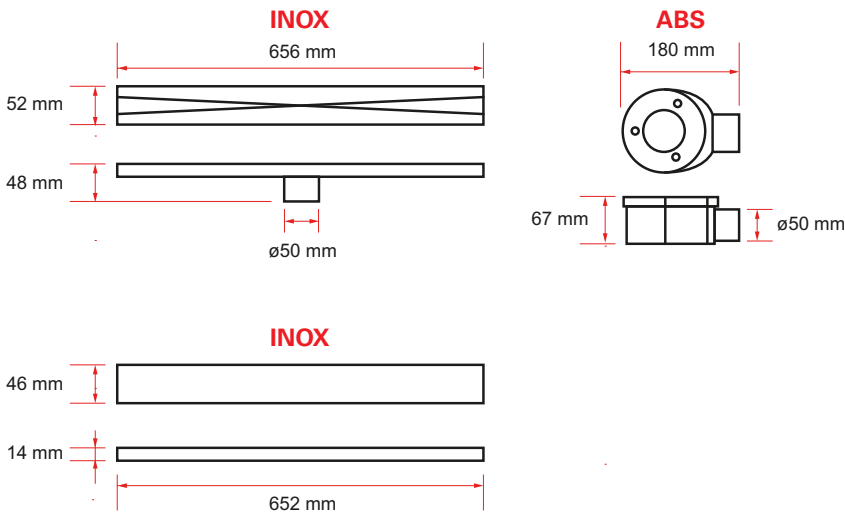

CANALETTA PER DOCCIA CON GRIGLIA INOX
LINEAR SHOWER DRAIN WITH INOX GRATING

Il Kit comprende il corpo sifonato, il foglio di guaina impermeabilizzante con adattatore incorporato, la vaschetta, il filtro e la griglia.

Materiale:

- Vaschetta in PVC
- Corpo sifonato e filtro in ABS
- Griglia e cornice della vaschetta in Acciaio INOX
- Waterproofing sheet composed of two external layers of polypropylene + an inner layer of polyethylene.

The kit includes the siphon body, the waterproofing sheet with builtin adapter, the drain body, the filter and the grid.

Material:

- Drain body, adapter and filter in ABS.
- Grid and body frame in stainless steel AISI 304.
- Waterproofing sheet composed of two external layers of polypropylene + an inner layer of polyethylene.



Chiavetta per la rimozione della griglia inclusa
Key for grille removal included

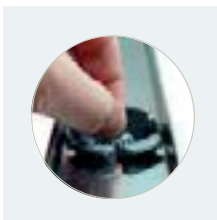

Filtro rimovibile
Removable filter



Uscita ø50
Ø50 outlet



Disponibili anche le lunghezze 550 mm - 750 mm - 850 mm - 950 mm (minimo 5 pezzi)
Other length available 550 mm - 750 mm - 850 mm - 950 mm (minimum 5 pieces)

Dimensioni Size	Portata Water flow			Quantità per conf. Pcs. box
mm	lpm	Cod. Art./Item Code	€/pz	pz/pcs

SPECIAL LINEARG				
ACCIAIO S-STEEL	658x53	200	SPCLA065ILOG	1

Canaletta/Frame

ABS

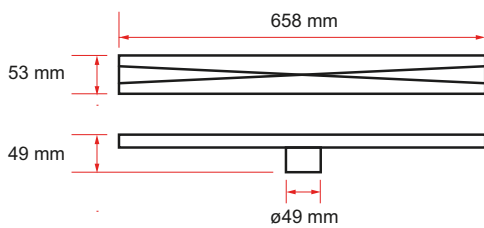

Corpo sifonato/Drain body

ABS

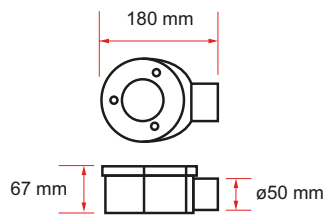

Griglia/Grid

INOX

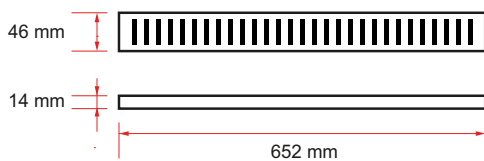

CANALETTA PER DOCCIA CON GRIGLIA INOX
LINEAR SHOWER DRAIN WITH INOX GRATING

Il Kit comprende il corpo sifonato, il foglio di guaina impermeabilizzante con adattatore incorporato, la vaschetta, il filtro e la griglia.

Materiale:

- Vaschetta in PVC
- Corpo sifonato, canaletta e filtro in ABS
- Griglia INOX
- Waterproofing sheet composed of two external layers of polypropylene + an inner layer of polyethylene.

The kit includes the siphon body, the waterproofing sheet with builtin adapter, the drain body, the filter and the grid.

Materiale:

- Drain body, frame adapter and filter in ABS.
- Grid in stainless steel AISI 304.
- Waterproofing sheet composed of two external layers of polypropylene + an inner layer of polyethylene.



Chiavetta per la rimozione della griglia inclusa
Key for grille removal included

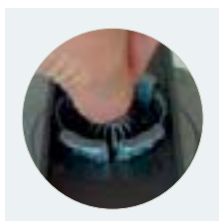

Filtro rimovibile
Removable filter



Uscita ø50
Ø50 outlet

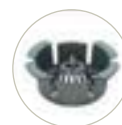

Filtro raccogli capelli
Hair collection filter



Corpo sifonato con guarnizione
Siphoned body with gasket



Corpo sifonato
Siphoned body



**SPECIAL
PROFILES**

Sistemi di drenaggio

Draining and shower systems

Dimensioni Size	Portata Water flow			Quantità per conf. Pcs. box
mm	lpm	Cod. Art./Item Code	€/pz	pz/pcs

SPECIAL LINEARPG				
ACCIAIO S-STEEL	656x52	200	SPCL0065ILPG	1

Canaletta/Frame

INOX

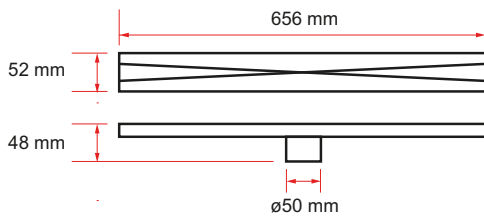

Corpo sifonato/Drain body

ABS

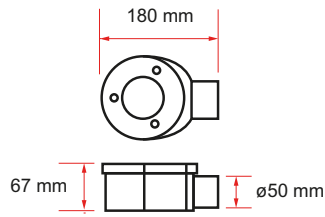

CANALETTA PER DOCCIA CON PORTAPIASTRELLE INOX LINEAR SHOWER DRAIN WITH INOX TILE TRAY

Il Kit comprende il corpo sifonato, il foglio di guaina impermeabilizzante con adattatore incorporato, la vaschetta, il filtro e il portapiastrelle.

Materiale:

- Corpo sifonato e filtro in ABS
- Canaletta e portapiastrella in Acciaio INOX

The kit includes the siphon body, the waterproofing sheet with builtin adapter, the drain body, the filter and the tile tray.

Material:

- Drain body, adapter and filter in ABS.
- Tile tray and body frame in stainless steel AISI 304.
- Waterproofing sheet composed of two external layers of polypropylene + an inner layer of polyethylene.

Portapiastrella/Tile tray

INOX

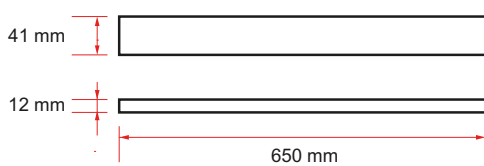

Filtro rimovibile
Removable filter



Uscita ø50
Ø50 outlet

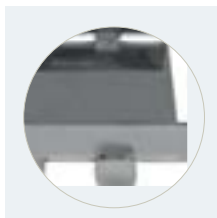

Il porta piastrella è dotato di fermi in gomma
The tile holder is equipped with rubber stops

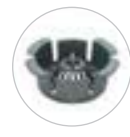

Filtro raccogli capelli
Hair collection filter



Corpo sifonato con guarnizione
Siphoned body with gasket

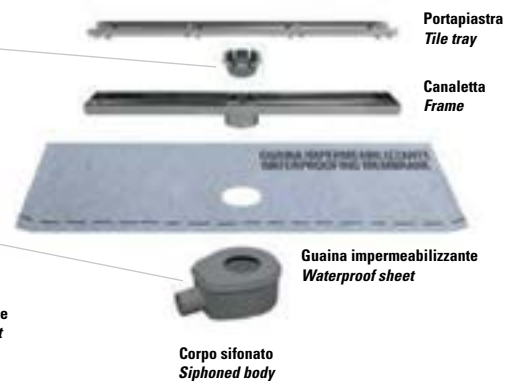

Disponibili anche le lunghezze 550 mm - 750 mm - 850 mm - 950 mm (minimo 5 pezzi)
Other length available 550 mm - 750 mm - 850 mm - 950 mm (minimum 5 pieces)

	Dimensioni Size	Portata Water flow			Quantità per conf. Pcs. box
SPECIAL LINEARPG	mm	lpm	Cod. Art./Item Code	€/pz	pz/pcs
ACCIAIO S-STEEL	658x53	200	SPCLA065ILPG		1

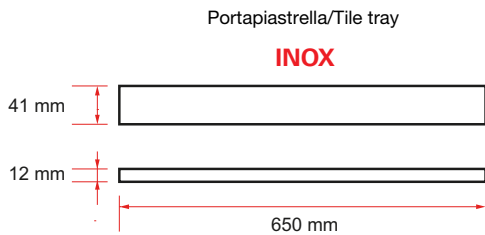
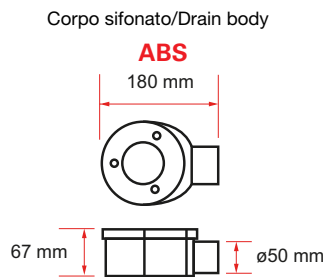
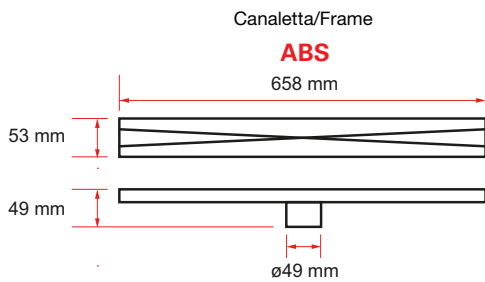

**CANALETTA PER DOCCIA CON PORTAPIASTRELLA INOX
LINEAR SHOWER DRAIN WITH INOX TILE TRAY**

Il Kit comprende il corpo sifonato, il foglio di guaina impermeabilizzante con adattatore incorporato, la vaschetta, il filtro e il portapiastrella.

Materiale:

- Corpo sifonato, canaletta e filtro in ABS
- Portapiastrella in INOX

The kit includes the siphon body, the waterproofing sheet with builtin adapter, the drain body, the filter and the tile tray.

Material:

- Drain body, adapter frame and filter in ABS.
- Tile tray in stainless steel AISI 304.

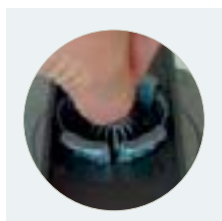

Filtro rimovibile
Removable filter



Uscita ø50
Ø50 outlet





SPECIAL
PROFILES

Giunti di Dilatazione, accessori per la posa

Movement joints – Accessories for laying



	Larghezza Width T	Altezza Height H	Lunghezza Length		PVC grigio/trasparente Grey/transparent PVC	Quantità per conf. Pcs. box
SPECIAL FLEX-PVC	mm	mm	m	Cod. Art./Item Code	€/pz	pz/pcs

PVC PVC

8	8	2	SPFX0808PVG2		50
	10		SPFX1008PVG2		
	12		SPFX1208PVG2		
	14		SPFX1408PVG2		

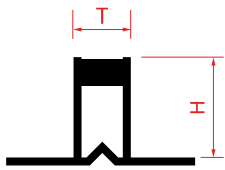

	Spessore Thickness S		PVC grigio Grey PVC	Quantità per conf. Pcs. box	Quantità per busta Pcs. bags
SPECIAL DCROSS-PVC	mm	Cod. Art./Item Code	€/busta/bag	pz/pcs	pz/pcs

PVC PVC

1	SPDC0001PVG		80	250
2	SPDC0002PVG		80	250
3	SPDC0003PVG		68	250
4	SPDC0004PVG		63	250
5	SPDC0005PVG		60	250
7	SPDC0007PVG		30	250
10	SPDC0010PVG		20	250

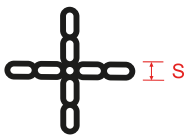

SPECIAL DTI-PVC					

PVC PVC

2	SPDT0002PVG		80	250
3	SPDT0003PVG		68	250
4	SPDT0004PVG		63	250
5	SPDT0005PVG		60	250
7	SPDT0007PVG		30	250
10	SPDT0010PVG		20	250



	Dimensioni Size S		PVC PVC	Quantità per conf. Pcs. box
SPECIAL-DCU-PVC	mm	Cod. Art./Item Code	€/busta/bag	pz/pcs

PVC PVC

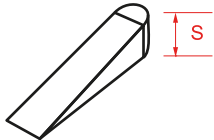

0-5	SPDU0005PVG		40 buste da 500 pz 40 bag-500 pcs/bag
0-10	SPDU0010PVG		16 buste da 500 pz 16 bag-500 pcs/bag

Distanziatori autolivellanti

Self leveling spacers

	Dimensioni Size S		PVC PVC	Quantità per conf. Pcs. box
SPECIAL-DCUX-PVC	mm	Cod. Art./Item Code	€/busta/bag	pz/pcs

PVC PVC

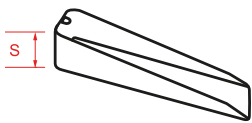

22	SPDU0022PVG		4 buste da 250 pz 4 bag-250 pcs/bag
----	-------------	--	--

Altezza mattonelle Tiles height	Dimensioni Size S	Colore Colours		PVC PVC	Quantità per conf. Pcs. box
mm			Cod. Art./Item Code	€/busta/bag	pz/pcs

	Altezza mattonelle Tiles height	Dimensioni Size S	Colore Colours		PVC PVC	Quantità per conf. Pcs. box
SPECIAL-TC-PVC	3-12	0,5	verde/green	SPDR0005PVG		10 buste da 250 pz 10 bag-250 pcs/bag
	3-12	1	grigio/grey	SPDR0001PVG		
	3-12	1,5	blu/bleu	SPDR0015PVG		
	3-12	2	bianco/white	SPDR0002PVG		
	3-12	3	giallo/yellow	SPDR0003PVG		
	10-20	2	arancio/orange	SPDR0020PVG		8 buste da 250 pz 8 bag-250 pcs/bag

PVC PVC

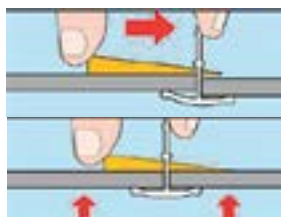
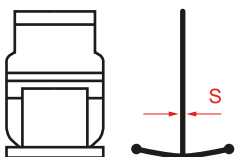



SPECIAL
PROFILES

Profili in Alluminio per il Fai da Te

Aluminium Do It Yourself Profiles

**PROFILI ALLUMINIO
ANODIZZATO ARGENTO**
 Silver Anodized
 Aluminium Profiles

PIATTO
 FLAT BAR

Spessore Thickness T	Dimensioni Size W	Lunghezza Length	completa il cod. art. (xxx) con il tipo di finitura complete item code (xxx) with the finish type	Naturale Natural	Satinato Anodized	Brillante Bright	Verniciato Bianco White painted	Quantità per conf. Pcs. box
				(ANA)	(AAA)	(ABA)	(AVB)	
mm	mm	m	Cod. Art./Item Code	€/pz	€/pz	€/pz	€/pz	pz/pcs

ALLUMINIO ALUMINIUM



2	10	1	SPPI1002xxx01					10
		2	SPPI1002xxx02					
		3	SPPI1002xxx03					
	12	1	SPPI1202xxx01					
		2	SPPI1202xxx02					
		3	SPPI1202xxx03					
	15	1	SPPI1502xxx01					
		2	SPPI1502xxx02					
		3	SPPI1502xxx03					
	20	1	SPPI2002xxx01					
		2	SPPI2002xxx02					
		3	SPPI2002xxx03					
	25	1	SPPI2502xxx01					
		2	SPPI2502xxx02					
		3	SPPI2502xxx03					
	30	1	SPPI3002xxx01					
		2	SPPI3002xxx02					
		3	SPPI3002xxx03					
	35	1	SPPI3502xxx01					
		2	SPPI3502xxx02					
		3	SPPI3502xxx03					
	40	1	SPPI4002xxx01					
		2	SPPI4002xxx02					
		3	SPPI4002xxx03					
50	1	SPPI5002xxx01						
	2	SPPI5002xxx02						
	3	SPPI5002xxx03						

**PROFILI ALLUMINIO
ANODIZZATO ARGENTO**
Silver Anodized
Aluminium Profiles

ANGOLARE
EQUAL SIDED ANGLE

Spessore Thickness T	Dimensioni Size W	Lunghezza Length	completa il cod. art. (xxx) con il tipo di finitura complete item code (xxx) with the finish type	Naturale <i>Natural</i>	Satinato <i>Anodized</i>	Brillante <i>Bright</i>	Verniciato Bianco White painted	Quantità per conf. <i>Pcs. box</i>
				(ANA)	(AAA)	(ABA)	(AVB)	
mm	mm	m	Cod. Art./Item Code	€/pz	€/pz	€/pz	€/pz	pz/pcs

ALLUMINIO ALUMINIUM

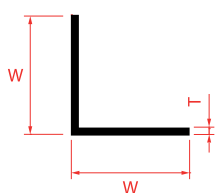

1	10	1	SPAN1010xxx01					10
		2	SPAN1010xxx02					
		3	SPAN1010xxx03					
	15	1	SPAN1515xxx01					
		2	SPAN1515xxx02					
		3	SPAN1515xxx03					
	20	1	SPAN2020xxx01					
		2	SPAN2020xxx02					
		3	SPAN2020xxx03					
	25	1	SPAN2525xxx01					
		2	SPAN2525xxx02					
		3	SPAN2525xxx03					
	30	1	SPAN3030xxx01					
		2	SPAN3030xxx02					
		3	SPAN3030xxx03					
1,5	40	1	SPAN4040xxx01					
		2	SPAN4040xxx02					
		3	SPAN4040xxx03					
	50	1	SPAN5050xxx01					
		2	SPAN5050xxx02					
		3	SPAN5050xxx03					

Completare il Cod. Art. con il tipo di finitura: es. Alluminio Naturale (**ANA**) -> SPPI0802**ANA**01
Complete item code with the finish type: e.g. for Natural Aluminium (**ANA**) -> SPPI0802**ANA**01

**PROFILI ALLUMINIO
ANODIZZATO ARGENTO**
 Silver Anodized
 Aluminium Profiles

"L"
UN-EQUAL SIDED ANGLE

Spessore Thickness T	Dimensioni Size WxH	Lunghezza Length	completa il cod. art. (xxx) con il tipo di finitura complete item code (xxx) with the finish type	Naturale <i>Natural</i>	Satinato <i>Anodized</i>	Brillante <i>Bright</i>	Verniciato Bianco White painted	Quantità per conf. <i>Pcs. box</i>
				(ANA)	(AAA)	(ABA)	(AVB)**	
mm	mm	m	Cod. Art./Item Code	€/pz	€/pz	€/pz	€/pz	pz/pcs

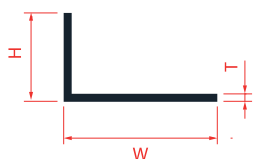
ALLUMINIO ALUMINIUM

1	15x10	1	SPEL1510xxx01					10
		2	SPEL1510xxx02					
		3	SPEL1510xxx03					
	20x10	1	SPEL2010xxx01					
		2	SPEL2010xxx02					
		3	SPEL2010xxx03					
	25x15	1	SPEL2515xxx01					
		2	SPEL2515xxx02					
		3	SPEL2515xxx03					
	30x15	1	SPEL3015xxx01					
		2	SPEL3015xxx02					
		3	SPEL3015xxx03					
	30x20	1	SPEL3020xxx01					
		2	SPEL3020xxx02					
		3	SPEL3020xxx03					
	40x10	1	SPEL4010xxx01					
		2	SPEL4010xxx02					
		3	SPEL4010xxx03					
	40x15	1	SPEL4015xxx01					
		2	SPEL4015xxx02					
		3	SPEL4015xxx03					

* Articolo a richiesta. Ordine minimo 100 pz
 * Article on request. Minimum order 100 pcs

Completare il Cod. Art. con il tipo di finitura: es. Alluminio Naturale (**ANA**) -> SPPI0802**ANA**01
 Complete item code with the finish type: e.g. for Natural Aluminium (**ANA**) -> SPPI0802**ANA**01

**PROFILI ALLUMINIO
ANODIZZATO ARGENTO**
Silver Anodized
Aluminium Profiles

"U"
U PROFILE

Spessore Thickness T	Dimensioni Size WxH	Lunghezza Length	completa il cod. art. (xxx) con il tipo di finitura complete item code (xxx) with the finish type	Naturale <i>Natural</i>	Satinato <i>Anodized</i>	Brillante <i>Bright</i>	Verniciato Bianco White painted	Quantità per conf. <i>Pcs. box</i>
				(ANA)	(AAA)	(ABA)	(AVB)* **	
mm	mm	m	Cod. Art./Item Code	€/pz	€/pz	€/pz	€/pz	pz/pcs

ALLUMINIO ALUMINIUM

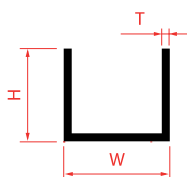

1	8x8	1	SPCU0808xxx01					10
		2	SPCU0808xxx02					
		3	SPCU0808xxx03					
	10x10	1	SPCU1010xxx01					
		2	SPCU1010xxx02					
		3	SPCU1010xxx03					
	10x15	1	SPCU1015xxx01					
		2	SPCU1015xxx02					
		3	SPCU1015xxx03					
	12x12	1	SPCU1212xxx01					
		2	SPCU1212xxx02					
		3	SPCU1212xxx03					
	15x10	1	SPCU1510xxx01					
		2	SPCU1510xxx02					
		3	SPCU1510xxx03					
	15x15	1	SPCU1515xxx01					
		2	SPCU1515xxx02					
		3	SPCU1515xxx03					
	20x20	1	SPCU2020xxx01					
		2	SPCU2020xxx02					
		3	SPCU2020xxx03					

* Articolo a richiesta. Ordine minimo 100 pz

* Article on request. Minimum order 100 pcs

 Completare il Cod. Art. con il tipo di finitura: es. Alluminio Naturale (**ANA**) -> SPPI0802**ANA**01
 Complete item code with the finish type: e.g. for Natural Aluminium (**ANA**) -> SPPI0802**ANA**01

**PROFILI ALLUMINIO
ANODIZZATO ARGENTO**
 Silver Anodized
 Aluminium Profiles

DOPPIA "U"
UU PROFILE

Spessore Thickness T	Dimensioni Size WxH	Lunghezza Length L	completa il cod. art. (xxx) con il tipo di finitura <i>complete item code (xxx) with the finish type</i>	Naturale <i>Natural</i>	Satinato <i>Anodized</i>	Brillante <i>Bright</i>	Verniciato Bianco White painted	Quantità per conf. <i>Pcs. box</i>
				(ANA)	(AAA)	(ABA)	(AVB)* **	
mm	mm	m	Cod. Art./Item Code	€/pz	€/pz	€/pz	€/pz	pz/pcs

ALLUMINIO ALUMINIUM

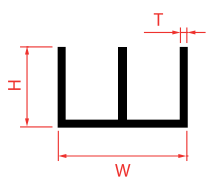

1	16x7	1	SPUU1607xxx01					10
		2	SPUU1607xxx02					
		3	SPUU1607xxx03					
	16x12	1	SPUU1612xxx01					
		2	SPUU1612xxx02					
		3	SPUU1612xxx03					
	20x10	1	SPUU2010xxx01					
		2	SPUU2010xxx02					
		3	SPUU2010xxx03					
	20x18	1	SPUU2018xxx01					
		2	SPUU2018xxx02					
		3	SPUU2018xxx03					

TONDO PIENO
ROUND BAR

mm	D ø mm	m	Cod. Art./Item Code	€/pz	€/pz	€/pz	€/pz	pz/pcs
----	------------------	---	---------------------	------	------	------	------	--------

ALLUMINIO ALUMINIUM

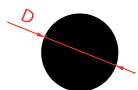

1	6	1	SPTP0006xxx01					10
		2	SPTP0006xxx02					
		3	SPTP0006xxx03					
	8	1	SPTP0008xxx01					
		2	SPTP0008xxx02					
		3	SPTP0008xxx03					
	10	1	SPTP0010xxx01					
		2	SPTP0010xxx02					
		3	SPTP0010xxx03					
	12	1	SPTP0012xxx01					
		2	SPTP0012xxx02					
		3	SPTP0012xxx03					

* Articolo a richiesta. Ordine minimo 100 pz
 * Article on request. Minimum order 100 pcs

Completare il Cod. Art. con il tipo di finitura: es. Alluminio Naturale (**ANA**) -> SPPI0802**ANA**01
 Complete item code with the finish type: e.g. for Natural Aluminium (**ANA**) -> SPPI0802**ANA**01

**PROFILI ALLUMINIO
ANODIZZATO ARGENTO**
Silver Anodized
Aluminium Profiles

TUBO TONDO
ROUND TUBE

Spessore Thickness T	Dimensioni Size D	Lunghezza Length L	completa il cod. art. (xxx) con il tipo di finitura complete item code (xxx) with the finish type	Naturale <i>Natural</i>	Satinato <i>Anodized</i>	Brillante <i>Bright</i>	Verniciato Bianco White painted	Quantità per conf. Pcs. box
				(ANA)	(AAA)	(ABA)	(AVB)* **	
mm	mm	m	Cod. Art./Item Code	€/pz	€/pz	€/pz	€/pz	pz/pcs

ALLUMINIO ALUMINIUM

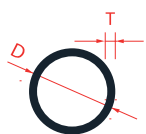

1	6	1	SPTT0601xxx01					10
		2	SPTT0601xxx02					
		3	SPTT0601xxx03					
	8	1	SPTT0801xxx01					
		2	SPTT0801xxx02					
		3	SPTT0801xxx03					
	10	1	SPTT1001xxx01					
		2	SPTT1001xxx02					
		3	SPTT1001xxx03					
	12	1	SPTT1201xxx01					
		2	SPTT1201xxx02					
		3	SPTT1201xxx03					
	16	1	SPTT1601xxx01					
		2	SPTT1601xxx02					
		3	SPTT1601xxx03					
	18	1	SPTT1801xxx01					
		2	SPTT1801xxx02					
		3	SPTT1801xxx03					
	20	1	SPTT2001xxx01					
		2	SPTT2001xxx02					
		3	SPTT2001xxx03					
	24	1	SPTT2401xxx01					
		2	SPTT2401xxx02					
		3	SPTT2401xxx03					

* Articolo a richiesta. Ordine minimo 100 pz

* Article on request. Minimum order 100 pcs

Completare il Cod. Art. con il tipo di finitura: es. Alluminio Naturale (**ANA**) -> SPPI0802**ANA**01Complete item code with the finish type: e.g. for Natural Aluminium (**ANA**) -> SPPI0802**ANA**01

**PROFILI ALLUMINIO
ANODIZZATO ARGENTO**
 Silver Anodized
 Aluminium Profiles

TUBO QUADRO
 SQUARE TUBE

Spessore Thickness T	Dimensioni Size WxH	Lunghezza Length L	completa il cod. art. (xxx) con il tipo di finitura complete item code (xxx) with the finish type	Naturale <i>Natural</i>	Satinato <i>Anodized</i>	Brillante <i>Bright</i>	Verniciato Bianco White painted	Quantità per conf. <i>Pcs. box</i>
				(ANA)	(AAA)	(ABA)	(AVB)* **	
mm	mm	m	Cod. Art./Item Code	€/pz	€/pz	€/pz	€/pz	pz/pcs

ALLUMINIO ALUMINIUM

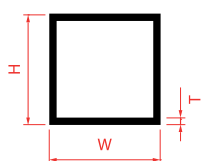

1	10x10	1	SPTQ1010xxx01					10
		2	SPTQ1010xxx02					
		3	SPTQ1010xxx03					
	15x15	1	SPTQ1515xxx01					
		2	SPTQ1515xxx02					
		3	SPTQ1515xxx03					
	20x20	1	SPTQ2020xxx01					
		2	SPTQ2020xxx02					
		3	SPTQ2020xxx03					

QUADRO PIENO
 SQUARE BAR

ALLUMINIO ALUMINIUM

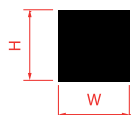

1	8x8	1	SPQP0808xxx01					10
		2	SPQP0808xxx02					
		3	SPQP0808xxx03					
	10x10	1	SPQP1010xxx01					
		2	SPQP1010xxx02					
		3	SPQP1010xxx03					

TUBO RETTANGOLARE
 RECTANGULAR TUBE

ALLUMINIO ALUMINIUM

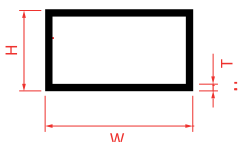

1	20x10	1	SPTR2010xxx01					10
		2	SPTR2010xxx02					
		3	SPTR2010xxx03					
	30x15	1	SPTR3015xxx01					
		2	SPTR3015xxx02					
		3	SPTR3015xxx03					

* Articolo a richiesta. Ordine minimo 100 pz

* Article on request. Minimum order 100 pcs

 Completare il Cod. Art. con il tipo di finitura: es. Alluminio Naturale (**ANA**) -> SPPI0802**ANA**01
 Complete item code with the finish type: e.g. for Natural Aluminium (**ANA**) -> SPPI0802**ANA**01

**PROFILI ALLUMINIO
ANODIZZATO ARGENTO**
Silver Anodized
Aluminium Profiles

Spessore Thickness T	Dimensioni Size WxH	Lunghezza Length	completa il cod. art. (xxx) con il tipo di finitura complete item code (xxx) with the finish type	Naturale Natural	Satinato Anodized	Brillante Bright	Verniciato Bianco White painted	Quantità per conf. Pcs. box
				(ANA)	(AAA)	(ABA)	(AVB)* **	
"T" T PROFILE	mm	mm	Cod. Art./Item Code	€/pz	€/pz	€/pz	€/pz	pz/pcs

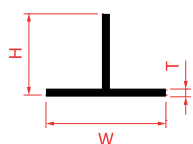
ALLUMINIO ALUMINIUM

1,5	15x15	1	SPPT1515xxx01					10
		2	SPPT1515xxx02					
		3	SPPT1515xxx03					
	20x20	1	SPPT2020xxx01					
		2	SPPT2020xxx02					
		3	SPPT2020xxx03					
	25x25	1	SPPT2525xxx01					
		2	SPPT2525xxx02					
		3	SPPT2525xxx03					
	30x15	1	SPPT3015xxx01					
		2	SPPT3015xxx02					
		3	SPPT3015xxx03					

**PROFILI ALLUMINIO
ANODIZZATO ARGENTO**
Silver Anodized
Aluminium Profiles

Spessore Thickness T	Dimensioni Size WxH	Lunghezza Length	completa il cod. art. (xxx) con il tipo di finitura complete item code (xxx) with the finish type	Naturale Natural	Satinato Anodized	Brillante Bright	Verniciato Bianco White painted	Quantità per conf. Pcs. box
				(ANA)	(AAA)	(ABA)	(AVB)* **	
UNGHIETTA J-PROFILE	mm	mm	Cod. Art./Item Code	€/pz	€/pz	€/pz	€/pz	pz/pcs

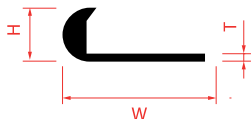
ALLUMINIO ALUMINIUM

1	18x7	1	SPUN1807xxx01					10
		2	SPUN1807xxx02					
		3	SPUN1807xxx03					
	22x7	1	SPUN2207xxx01					
		2	SPUN2207xxx02					
		3	SPUN2207xxx03					

* Articolo a richiesta. Ordine minimo 100 pz

* Article on request. Minimum order 100 pcs

Completare il Cod. Art. con il tipo di finitura: es. Alluminio Naturale (**ANA**) -> SPPI0802**ANA**01
Complete item code with the finish type: e.g. for Natural Aluminium (**ANA**) -> SPPI0802**ANA**01

PIATTO FLAT BAR	Spessore Thickness T	Dimensioni Size W	Lunghezza Length	completa il cod. art. (xxx) con il tipo di finitura complete item code (xxx) with the finish type	Nero satinato Anodized black (AAN)	Nero brillante Bright black (ABN)**	Quantità per conf. Pcs. box
	mm	mm	m	Cod. Art./Item Code	€/pz	€/pz	pz/pcs

ALLUMINIO ALUMINIUM



2	10	1	SPPI1002xxx01				10
		2	SPPI1002xxx02				
		3	SPPI1002xxx03				
	12	1	SPPI1202xxx01				
		2	SPPI1202xxx02				
		3	SPPI1202xxx03				
	15	1	SPPI1502xxx01				
		2	SPPI1502xxx02				
		3	SPPI1502xxx03				
	20	1	SPPI2002xxx01				
		2	SPPI2002xxx02				
		3	SPPI2002xxx03				
	25	1	SPPI2502xxx01				
		2	SPPI2502xxx02				
		3	SPPI2502xxx03				
	30	1	SPPI3002xxx01				
		2	SPPI3002xxx02				
		3	SPPI3002xxx03				
	35	1	SPPI3502xxx01				
		2	SPPI3502xxx02				
		3	SPPI3502xxx03				
	40	1	SPPI4002xxx01				
		2	SPPI4002xxx02				
		3	SPPI4002xxx03				
50	1	SPPI5002xxx01					
	2	SPPI5002xxx02					
	3	SPPI5002xxx03					

* Articolo a richiesta. Ordine minimo 100 pz

* Article on request. Minimum order 100 pcs

 Completare il Cod. Art. con il tipo di finitura: es. Alluminio Naturale (ANA) -> SPPI0802ANA01
 Complete item code with the finish type: e.g. for Natural Aluminium (ANA) -> SPPI0802ANA01



ANGOLARE EQUAL SIDED ANGLE	Spessore Thickness T	Dimensioni Size W	Lunghezza Length	completa il cod. art. (xxx) con il tipo di finitura complete item code (xxx) with the finish type	Nero satinato Anodized black (AAN)	Nero brillante Bright black (ABN)**	Quantità per conf. Pcs. box
	mm	mm	m	Cod. Art./Item Code	€/pz	€/pz	pz/pcs

ALLUMINIO ALUMINIUM

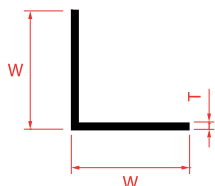

1	10	1	SPAN1010xxx01			10
		2	SPAN1010xxx02			
		3	SPAN1010xxx03			
	15	1	SPAN1515xxx01			
		2	SPAN1515xxx02			
		3	SPAN1515xxx03			
	20	1	SPAN2020xxx01			
		2	SPAN2020xxx02			
		3	SPAN2020xxx03			
	25	1	SPAN2525xxx01			
		2	SPAN2525xxx02			
		3	SPAN2525xxx03			
	30	1	SPAN3030xxx01			
		2	SPAN3030xxx02			
		3	SPAN3030xxx03			
1,5	40	1	SPAN4040xxx01			
		2	SPAN4040xxx02			
		3	SPAN4040xxx03			
	50	1	SPAN5050xxx01			
		2	SPAN5050xxx02			
		3	SPAN5050xxx03			

* Articolo a richiesta. Ordine minimo 100 pz
* Article on request. Minimum order 100 pcs

Completare il Cod. Art. con il tipo di finitura: es. Alluminio Naturale (ANA) -> SPPI0802ANA01
Complete item code with the finish type: e.g. for Natural Aluminium (ANA) -> SPPI0802ANA01

"L" UN-EQUAL SIDED ANGLE	Spessore Thickness T	Dimensioni Size W	Lunghezza Length	completa il cod. art. (xxx) con il tipo di finitura complete item code (xxx) with the finish type	Nero satinato Anodized black (AAN)	Nero brillante Bright black (ABN)**	Quantità per conf. Pcs. box
	mm	mm	m	Cod. Art./Item Code	€/pz	€/pz	pz/pcs

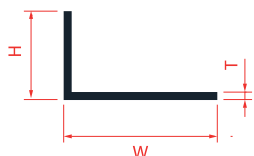
ALLUMINIO ALUMINIUM

1	15x10	1	SPEL1510xxx01			10
		2	SPEL1510xxx02			
		3	SPEL1510xxx03			
	20x10	1	SPEL2010xxx01			
		2	SPEL2010xxx02			
		3	SPEL2010xxx03			
	25x15	1	SPEL2515xxx01			
		2	SPEL2515xxx02			
		3	SPEL2515xxx03			
	30x15	1	SPEL3015xxx01			
		2	SPEL3015xxx02			
		3	SPEL3015xxx03			
	30x20	1	SPEL3020xxx01			
		2	SPEL3020xxx02			
		3	SPEL3020xxx03			
	40x10	1	SPEL4010xxx01			
		2	SPEL4010xxx02			
		3	SPEL4010xxx03			
	40x15	1	SPEL4015xxx01			
		2	SPEL4015xxx02			
		3	SPEL4015xxx03			

* Articolo a richiesta. Ordine minimo 100 pz
* Article on request. Minimum order 100 pcs

Completare il Cod. Art. con il tipo di finitura: es. Alluminio Naturale (ANA) -> SPPI0802ANA01
Complete item code with the finish type: e.g. for Natural Aluminium (ANA) -> SPPI0802ANA01

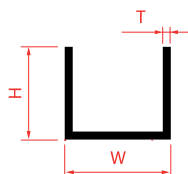

"U" U PROFILE	Spessore Thickness T	Dimensioni Size W	Lunghezza Length	completa il cod. art. (xxx) con il tipo di finitura complete item code (xxx) with the finish type	Nero satinato Anodized black (AAN)	Nero brillante Bright black (ABN)**	Quantità per conf. Pcs. box
	mm	mm	m	Cod. Art./Item Code	€/pz	€/pz	pz/pcs

ALLUMINIO ALUMINIUM

1	8x8	1	SPCU0808xxx01			10
		2	SPCU0808xxx02			
		3	SPCU0808xxx03			
	10x10	1	SPCU1010xxx01			
		2	SPCU1010xxx02			
		3	SPCU1010xxx03			
	10x15	1	SPCU1015xxx01			
		2	SPCU1015xxx02			
		3	SPCU1015xxx03			
	15x10	1	SPCU1510xxx01			
		2	SPCU1510xxx02			
		3	SPCU1510xxx03			
	15x15	1	SPCU1515xxx01			
		2	SPCU1515xxx02			
		3	SPCU1515xxx03			
	20x20	1	SPCU2020xxx01			
		2	SPCU2020xxx02			
		3	SPCU2020xxx03			

* Articolo a richiesta. Ordine minimo 100 pz
 * Article on request. Minimum order 100 pcs

PIATTO FLAT BAR	Spessore Thickness T	Dimensioni Size W	Lunghezza Length	completa il cod. art. (xxx) con il tipo di finitura complete item code (xxx) with the finish type	Oro satinato Anodized gold (AA0)	Oro brillante Bright gold (AB0)**	Quantità per conf. Pcs. box
	mm	mm	m	Cod. Art./Item Code	€/pz	€/pz	pz/pcs

ALLUMINIO ALUMINIUM



2	10	1	SPPI1002xxx01			10
		2	SPPI1002xxx02			
		3	SPPI1002xxx03			
	12	1	SPPI1202xxx01			
		2	SPPI1202xxx02			
		3	SPPI1202xxx03			
	15	1	SPPI1502xxx01			
		2	SPPI1502xxx02			
		3	SPPI1502xxx03			
	20	1	SPPI2002xxx01			
		2	SPPI2002xxx02			
		3	SPPI2002xxx03			
	25	1	SPPI2502xxx01			
		2	SPPI2502xxx02			
		3	SPPI2502xxx03			
	30	1	SPPI3002xxx01			
		2	SPPI3002xxx02			
		3	SPPI3002xxx03			
	35	1	SPPI3502xxx01			
		2	SPPI3502xxx02			
		3	SPPI3502xxx03			
	40	1	SPPI4002xxx01			
		2	SPPI4002xxx02			
		3	SPPI4002xxx03			
50	1	SPPI5002xxx01				
	2	SPPI5002xxx02				
	3	SPPI5002xxx03				

* Articolo a richiesta. Ordine minimo 100 pz

* Article on request. Minimum order 100 pcs

Completare il Cod. Art. con il tipo di finitura: es. Alluminio Naturale (**ANA**) -> SPPI0802**ANA**01
Complete item code with the finish type: e.g. for Natural Aluminium (**ANA**) -> SPPI0802**ANA**01

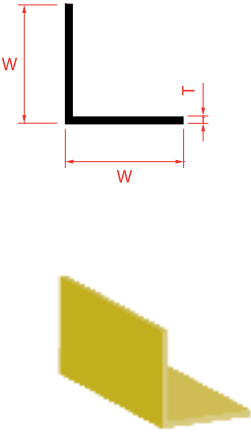

ANGOLARE EQUAL SIDED ANGLE	Spessore Thickness T	Dimensioni Size W	Lunghezza Length	completa il cod. art. (xxx) con il tipo di finitura complete item code (xxx) with the finish type	Oro satinato Anodized gold (AA0)	Oro brillante Bright gold (AB0)**	Quantità per conf. Pcs. box	
	mm	mm	m	Cod. Art./Item Code	€/pz	€/pz	pz/pcs	
ALLUMINIO ALUMINIUM 	1	10	1	SPAN1010xxx01			10	
			2	SPAN1010xxx02				
			3	SPAN1010xxx03				
		15	1	SPAN1515xxx01				
			2	SPAN1515xxx02				
			3	SPAN1515xxx03				
			20	1	SPAN2020xxx01			
				2	SPAN2020xxx02			
				3	SPAN2020xxx03			
	25	1	SPAN2525xxx01					
		2	SPAN2525xxx02					
		3	SPAN2525xxx03					
	30	1	SPAN3030xxx01					
		2	SPAN3030xxx02					
		3	SPAN3030xxx03					
	1,5	40	1	SPAN4040xxx01				
			2	SPAN4040xxx02				
			3	SPAN4040xxx03				
		50	1	SPAN5050xxx01				
			2	SPAN5050xxx02				
			3	SPAN5050xxx03				

* Articolo a richiesta. Ordine minimo 100 pz
 * Article on request. Minimum order 100 pcs

Completare il Cod. Art. con il tipo di finitura: es. Alluminio Naturale (ANA) -> SPPI0802ANA01
 Complete item code with the finish type: e.g. for Natural Aluminium (ANA) -> SPPI0802ANA01

"L" UN-EQUAL SIDED ANGLE	Spessore Thickness T	Dimensioni Size W	Lunghezza Length	completa il cod. art. (xxx) con il tipo di finitura complete item code (xxx) with the finish type	Oro satinato Anodized gold (AA0)	Oro brillante Bright gold (AB0)**	Quantità per conf. Pcs. box
	mm	mm	m	Cod. Art./Item Code	€/pz	€/pz	pz/pcs

ALLUMINIO ALUMINIUM

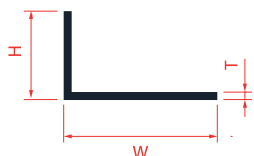

1	15x10	1	SPEL1510xxx01			10
		2	SPEL1510xxx02			
		3	SPEL1510xxx03			
	20x10	1	SPEL2010xxx01			
		2	SPEL2010xxx02			
		3	SPEL2010xxx03			
	25x15	1	SPEL2515xxx01			
		2	SPEL2515xxx02			
		3	SPEL2515xxx03			
	30x15	1	SPEL3015xxx01			
		2	SPEL3015xxx02			
		3	SPEL3015xxx03			
	30x20	1	SPEL3020xxx01			
		2	SPEL3020xxx02			
		3	SPEL3020xxx03			
	40x10	1	SPEL4010xxx01			
		2	SPEL4010xxx02			
		3	SPEL4010xxx03			
	40x15	1	SPEL4015xxx01			
		2	SPEL4015xxx02			
		3	SPEL4015xxx03			

* Articolo a richiesta. Ordine minimo 100 pz
* Article on request. Minimum order 100 pcs

Completare il Cod. Art. con il tipo di finitura: es. Alluminio Naturale (**ANA**) -> SPPI0802**ANA**01
Complete item code with the finish type: e.g. for Natural Aluminium (**ANA**) -> SPPI0802**ANA**01



TUBO TONDO ROUND TUBE	Spessore Thickness T	Dimensioni Size W	Lunghezza Length	completa il cod. art. (xxx) con il tipo di finitura complete item code (xxx) with the finish type	Oro satinato Anodized gold (AA0)	Oro brillante Bright gold (AB0)**	Quantità per conf. Pcs. box
	mm	mm	m	Cod. Art./Item Code	€/pz	€/pz	pz/pcs

ALLUMINIO ALUMINIUM

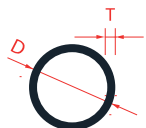

1	6	1	SPTT0601xxx01			10
		2	SPTT0601xxx02			
		3	SPTT0601xxx03			
	8	1	SPTT0801xxx01			
		2	SPTT0801xxx02			
		3	SPTT0801xxx03			
	10	1	SPTT1001xxx01			
		2	SPTT1001xxx02			
		3	SPTT1001xxx03			
	12	1	SPTT1201xxx01			
		2	SPTT1201xxx02			
		3	SPTT1201xxx03			
	16	1	SPTT1601xxx01			
		2	SPTT1601xxx02			
		3	SPTT1601xxx03			
	18	1	SPTT1801xxx01			
		2	SPTT1801xxx02			
		3	SPTT1801xxx03			
	20	1	SPTT2001xxx01			
		2	SPTT2001xxx02			
		3	SPTT2001xxx03			
	24	1	SPTT2401xxx01			
		2	SPTT2401xxx02			
		3	SPTT2401xxx03			

* Articolo a richiesta. Ordine minimo 100 pz

* Article on request. Minimum order 100 pcs

"U" U PROFILE	Spessore Thickness T	Dimensioni Size W	Lunghezza Length	completa il cod. art. (xxx) con il tipo di finitura complete item code (xxx) with the finish type	Oro satinato Anodized gold (AA0)	Oro brillante Bright gold (AB0)**	Quantità per conf. Pcs. box
	mm	mm	m	Cod. Art./Item Code	€/pz	€/pz	pz/pcs

ALLUMINIO ALUMINIUM

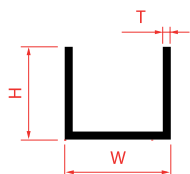

1	8x8	1	SPCU0808xxx01			10
		2	SPCU0808xxx02			
		3	SPCU0808xxx03			
	10x10	1	SPCU1010xxx01			
		2	SPCU1010xxx02			
		3	SPCU1010xxx03			
	10x15	1	SPCU1015xxx01			
		2	SPCU1015xxx02			
		3	SPCU1015xxx03			
	15x10	1	SPCU1510xxx01			
		2	SPCU1510xxx02			
		3	SPCU1510xxx03			
	15x15	1	SPCU1515xxx01			
		2	SPCU1515xxx02			
		3	SPCU1515xxx03			
	20x20	1	SPCU2020xxx01			
		2	SPCU2020xxx02			
		3	SPCU2020xxx03			

* Articolo a richiesta. Ordine minimo 100 pz

* Article on request. Minimum order 100 pcs



SPECIAL
PROFILES

Profili in Acciaio per il Fai da Te
S-Steel Do It Yourself Profiles

PROFILI ACCIAIO LUCIDO
 Polished S-Steel Profiles

PIATTO
FLAT BAR

Spessore <i>Thickness</i> T	Dimensioni <i>Size</i> W	completa il cod. art. (xx) con il tipo di lunghezza <i>complete item code (xx)</i> <i>with the length</i>	Lunghezza <i>Length</i>		Quantità per conf. <i>Pcs. box</i>
			(1 m)	(2 m)	
mm	mm	Cod. Art./Item Code	€/pz	€/pz	pz/pcs

ACCIAIO S-STEEL
AISI 304

0,7	10	SPPI1007ILAxx			10
	15	SPPI1507ILAxx			
	20	SPPI2007ILAxx			
	25	SPPI2507ILAxx			
	30	SPPI3007ILAxx			
	40	SPPI4007ILAxx			
	50	SPPI5007ILAxx			

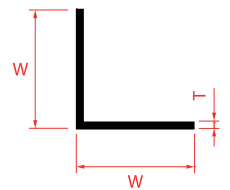
ANGOLARE
ANGLE, EQUAL SIDED
ACCIAIO S-STEEL
AISI 304

0,7	10	SPAN1007ILAxx			10
	15	SPAN1507ILAxx			
	20	SPAN2007ILAxx			
	30	SPAN3007ILAxx			
	40	SPAN4007ILAxx			
	50	SPAN5007ILAxx			



lunghezze superiori a 2 m disponibili solo su richiesta - lunghezza massima fornibile m 2.7.
lengths longer than 2 m available on request only - maximum length available 2.7 m.

Completare il Cod. Art. con la lunghezza barra: ad es.barra da 1 metro -> SPPI1007IL01 (01 = 1m) (02 = 2m)
Complete item code with the bar's length: e.g. for 1 m -> SPPI1007IL01 (01 = 1m) (02 = 2m)

PROFILI ACCIAIO LUCIDO
 Polished S-Steel Profiles

"L"
 UN-EQUAL SIDED ANGLE

Spessore Thickness T	Dimensioni Size WxH	completa il cod. art. (xx) con il tipo di lunghezza complete item code (xx) with the length	Lunghezza Length		Quantità per conf. Pcs. box
			(1 m)	(2 m)	
mm	mm	Cod. Art./Item Code	€/pz	€/pz	pz/pcs

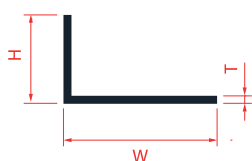
ACCIAIO S-STEEL
AISI 304

0,7	15x10	SPEL151007ILAxx			10
	20x10	SPEL201007ILAxx			
	30x20	SPEL302007ILAxx			
	40x10	SPEL401007ILAxx			

"U"

U PROFILE

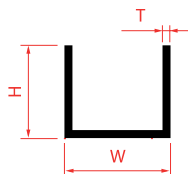
ACCIAIO S-STEEL
AISI 304

0,7	10x10	SPCU101007ILAxx			10
	10x15	SPCU101507ILAxx			
	10x20	SPCU102007ILAxx			
	15x10	SPCU151007ILAxx			
	15x15	SPCU151507ILAxx			
	20x20	SPCU202007ILAxx			



lunghezze superiori a 2 m disponibili solo su richiesta - lunghezza massima fornibile m 2.7.
 lengths longer than 2 m available on request only - maximum length available 2.7 m.

Completare il Cod. Art. con la lunghezza barra: ad es.barra da 1 metro -> SPPI1007IL01 (01 = 1m) (02 = 2m)
 Complete item code with the bar's length: e.g. for 1 m -> SPPI1007IL01 (01 = 1m) (02 = 2m)



SPECIAL
PROFILES

Profili in Ferro Naturale per il Fai da Te

Do It Yourself Iron profiles



PIATTO FLAT BAR	Spessore Thickness T	Dimensioni Size W	completa il cod. art. (xx) con il tipo di lunghezza <i>complete item code (xx) with the length</i>	Lunghezza Length		Quantità per conf. <i>Pcs. box</i>
	mm	mm	Cod. Art./Item Code	(1 m)	(2 m)	
				€/pz	€/pz	pz/pcs

FERRO IRON

3	15	SPPI1503FNxx			6
	20	SPPI2003FNxx			
	25	SPPI2503FNxx			
	30	SPPI3003FNxx			
4	40	SPPI4004FNxx			
5	50	SPPI5005FNxx			

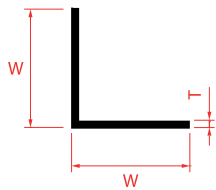
**ANGOLARE
EQUAL SIDED ANGLE**
FERRO IRON

3	15	SPAN1515FNxx			6
	20	SPAN2020FNxx			
	25	SPAN2525FNxx			
	30	SPAN3030FNxx			
	40	SPAN4040FNxx			

"L" UN-EQUAL SIDED ANGLE	Spessore Thickness T	Dimensioni Size WxH	completa il cod. art. (xx) con il tipo di lunghezza <i>complete item code (xx) with the length</i>	Lunghezza Length		Quantità per conf. <i>Pcs. box</i>
	mm	mm	Cod. Art./Item Code	(1 m)	(2 m)	
				€/pz	€/pz	pz/pcs

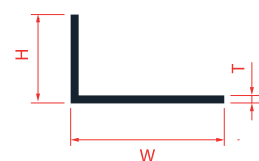
FERRO IRON

4	30x20	SPEL3020FNxx			6
	40x20	SPEL4020FNxx			

Completare il Cod. Art. con la lunghezza barra: ad es. barra da 1 metro -> SPPI1007IL01 (01 = 1m) (02 = 2m) (03 = 3m)
 Complete item code with the bar's length: e.g. for 1 m -> SPPI1007IL01 (01 = 1m) (02 = 2m) (03 = 3m)

"U"
U PROFILE

FERRO IRON

Spessore Thickness T	Dimensioni Size WxH	completa il cod. art. (xx) con il tipo di lunghezza complete item code (xx) with the length	Lunghezza Length		Quantità per conf. Pcs. box
			(1 m)	(2 m)	
mm	mm	Cod. Art./Item Code	€/pz	€/pz	pz/pcs

1,5	15x15	SPCU1515FNxx			6
	30x20	SPCU3020FNxx			

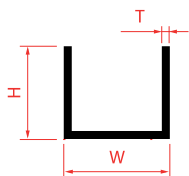

Spessore Thickness T	Dimensioni Size D	completa il cod. art. (xx) con il tipo di lunghezza complete item code (xx) with the length	Lunghezza Length		Quantità per conf. Pcs. box
			(1 m)	(2 m)	
mm	mm	Cod. Art./Item Code	€/pz	€/pz	pz/pcs

TONDO PIENO
ROUND BAR

FERRO IRON

	6	SPTP0006FNxx			6
	8	SPTP0008FNxx			
	10	SPTP0010FNxx			
	12	SPTP0012FNxx			
	16	SPTP0016FNxx			

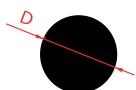

TUBO TONDO
ROUND TUBE

FERRO IRON

1	12	SPTT1201FNxx			6
	16	SPTT1601FNxx			
1,2	20	SPTT2001FNxx			
	25	SPTT2501FNxx			
1,5	30	SPTT3001FNxx			
	40	SPTT4001FNxx			

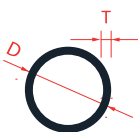

Completare il Cod. Art. con la lunghezza barra: ad es.barra da 1 metro -> SPPI1007/L01 (01 = 1m) (02 = 2m) (03 = 3m)
Complete item code with the bar's length: e.g. for 1 m -> SPPI1007/L01 (01 = 1m) (02 = 2m) (03 = 3m)



TUBO OVALE OVAL TUBE	Spessore Thickness T	Dimensioni Size WxH	completa il cod. art. (xx) con il tipo di lunghezza <i>complete item code (xx) with the length</i>	Lunghezza Length		Quantità per conf. <i>Pcs. box</i>
	mm	mm	Cod. Art./Item Code	(1 m)	(2 m)	
FERRO IRON				€/pz	€/pz	pz/pcs
	1,5	20x10	SPTO2010FNxx			6
		30x15	SPTO3015FNxx			

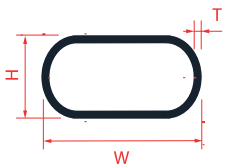

TUBO QUADRO SQUARE TUBE	FERRO IRON	1,5	12x12	SPTQ1212FNxx			6
			15x15	SPTQ1515FNxx			
			20x20	SPTQ2020FNxx			
			25x25	SPTQ2525FNxx			
			30x30	SPTQ3030FNxx			
			40x40	SPTQ4040FNxx			

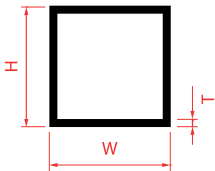

QUADRO PIENO SQUARE BAR	FERRO IRON		8x8	SPQP0808FNxx			6
			10x10	SPQP1010FNxx			
			12x12	SPQP1212FNxx			
			14x14	SPQP1414FNxx			

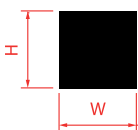

Completare il Cod. Art. con la lunghezza barra: ad es. barra da 1 metro -> SPPI1007IL01 (01 = 1m) (02 = 2m) (03 = 3m)
 Complete item code with the bar's length: e.g. for 1 m -> SPPI1007IL01 (01 = 1m) (02 = 2m) (03 = 3m)

TUBO RETTANGOLARE RECTANGULAR TUBE	Spessore Thickness T	Dimensioni Size WxH	completa il cod. art. (xx) con il tipo di lunghezza complete item code (xx) with the length	Lunghezza Length		Quantità per conf. Pcs. box
	mm	mm	Cod. Art./Item Code	(1 m)	(2 m)	
	€/pz	€/pz	pz/pcs			

FERRO IRON

1,5	30x20	SPTR3020FNxx			6
	40x20	SPTR4020FNxx			

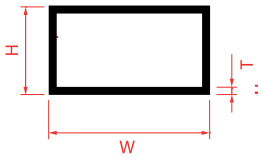

"T" T PROFILE	Spessore Thickness T	Dimensioni Size WxH	completa il cod. art. (xx) con il tipo di lunghezza complete item code (xx) with the length	Lunghezza Length		Quantità per conf. Pcs. box
FERRO IRON	mm	mm	Cod. Art./Item Code	(1 m)	(2 m)	
	€/pz	€/pz	pz/pcs			

"T"
T PROFILE

4	20x20	SPPT2020FNxx			6
	25x25	SPPT2525FNxx			
5	30x30	SPPT3030FNxx			

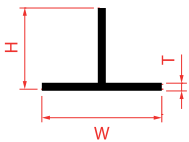

Completare il Cod. Art. con la lunghezza barra: ad es. barra da 1 metro -> SPP11007IL01 (01 = 1m) (02 = 2m) (03 = 3m)
Complete item code with the bar's length: e.g. for 1 m -> SPP11007IL01 (01 = 1m) (02 = 2m) (03 = 3m)

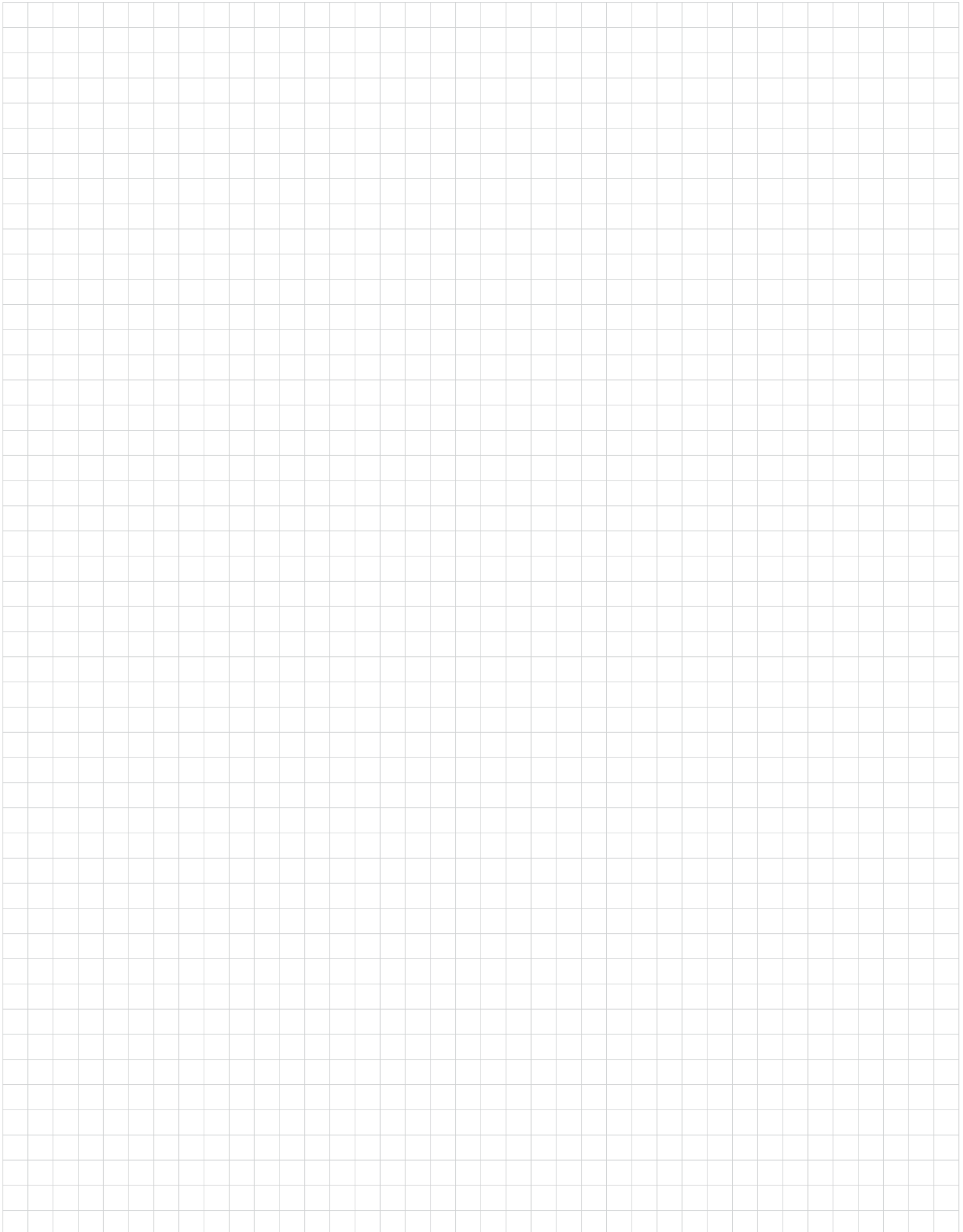



SPECIAL
PROFILES

Lamiere e Profili in Alluminio, Acciaio per il Fai da te

Aluminium, Iron, S-Steel sheets and Profiles for Do It Yourself

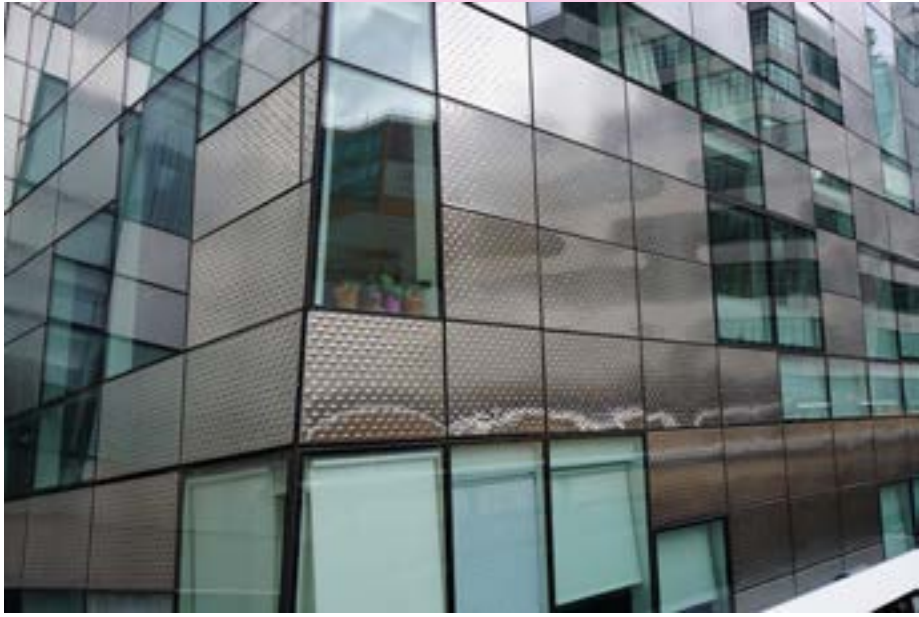

ANGOLARE EQUAL SIDE ANGLE	Spessore Thickness T	Dimensioni Size WxH	completa il cod. art. (xx) con il tipo di lunghezza complete item code (xx) with the length	Lunghezza Length		Quantità per conf. Pcs. box
	mm	mm	Cod. Art./Item Code	(1 m)	(2 m)	pz/pcs

ALLUMINIO ALUMINIUM

1,5	20x20	SPAN2020ANCxx			10
	25x25	SPAN2525ANCxx			
	30x30	SPAN3030ANCxx			
	40x40	SPAN4040ANCxx			

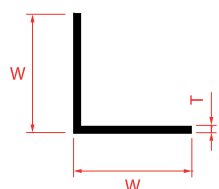

"L" UN-EQUAL SIDED ANGLE	1,5	40x20	SPEL4020ANCxx			10
		50x30	SPEL5030ANCxx			

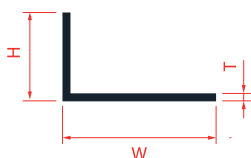
ALLUMINIO ALUMINIUM

"U" U PROFILE	1,5	22,5x22,5	SPCU2222ANCxx			10
		25,5x25,5	SPCU2525ANCxx			

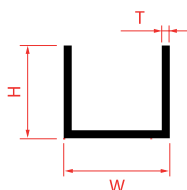
ALLUMINIO ALUMINIUM

lunghezze superiori a 2 m disponibili solo su richiesta - lunghezza massima fornibile m 2.7.
lengths longer than 2 m available on request only - maximum length available 2.7 m.

Completare il Cod. Art. con la lunghezza barra: ad es.barra da 1 metro -> SPP1007IL01 (01 = 1m) (02 = 2m)
Complete item code with the bar's length: e.g. for 1 m -> SPP1007IL01 (01 = 1m) (02 = 2m)



LAMIERE METAL SHEET	Spessore Thickness T	Dimensioni Size W	Dimensioni Size H			Quantità per conf. Pcs. box-S
	mm	mm	mm	Cod. Art./Item Code	€/pz	pz/pcs
ALLUMINIO LISCIO NATURALE SILVER NATURAL PLAIN ALUMINIUM	0,7	500	200	SPLA5020AN07		10
	0,7		400	SPLA5040AN07		
	0,7		500	SPLA5050AN07		
	0,7		600	SPLA5060AN07		
	0,7		1000	SPLA5010AN07		

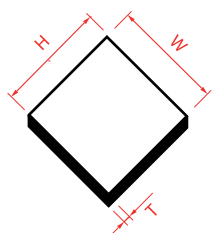

LAMIERE METAL SHEET	0,7	500	200	SPLA5020AAA07		10
	0,7		400	SPLA5040AAA07		
ALLUMINIO LISCIO ANODIZZATO SATINATO SILVER ANODIZED ALUMINIUM	0,7	500	500	SPLA5050AAA07		10
	0,7		600	SPLA5060AAA07		
	0,7		1000	SPLA5010AAA07		

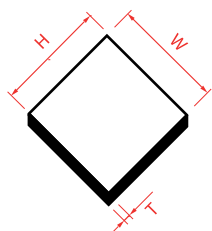

LAMIERE SHEET METAL	0,7	500	200	SPLA5020ABA07		10
	0,7		400	SPLA5040ABA07		
ALLUMINIO LISCIO BRILLANTE SILVER POLISHED PLAIN ALUMINIUM SHEET	0,7	500	500	SPLA5050ABA07		10
	0,7		600	SPLA5060ABA07		
	0,7		1000	SPLA5010ABA07		

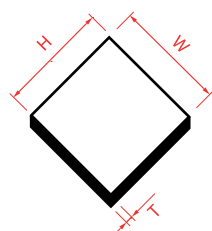

LAMIERE METAL SHEET	Spessore Thickness T	Dimensioni Size W	Dimensioni Size H			Quantità per conf. Pcs. box
	mm	mm	mm	Cod. Art./Item Code	€/pz	pz/pcs

**ALLUMINIO CHICCO DI
RISO NATURALE**
CHECKERED-PLATE NATURAL
ALUMINIUM SHEET

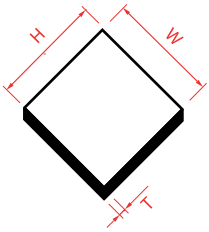

1,5	500	200	SPLC5020ANC02		10
		500	SPLC5050ANC02		
		600	SPLC5060ANC02		
	600	200	SPLC6020ANC02		
		600	SPLC6060ANC02		
		1000	SPLC6010ANC02		
	1250	1000	SPLC6010ANC02		
	1250	2000	SPLC6010ANC02		
	1000	2000	SPLC6010ANC02		
	1250	2500	SPLC6010ANC02		



LAMIERE METAL SHEET	0,7	500	200	SPLA5020IL07		10
	0,7		400	SPLA5040IL07		
	0,7		500	SPLA5050IL07		
	0,7		600	SPLA5060IL07		
	0,7		1000	SPLA5010IL07		

**ACCIAIO LISCIO
BRILLANTE**
POLISHED PLAIN
STEEL SHEET

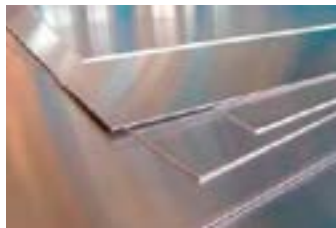
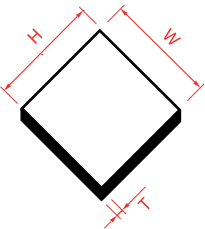

AC



**SPECIAL
PROFILES**

Lamiere Alluminio, Acciaio, Ferro per il Fai da te

Aluminium, Iron, S-Steel sheets for Do It Yourself

**LAMIERE STIRATE
STRETCHED SHEETS**

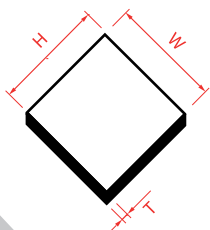
Spessore Thickness T	Dimensioni Size W	Dimensioni Size H		Acciaio S-Steel	Quantità per conf. Pcs. box
mm	mm	mm	Cod. Art./Item Code	€/pz	pz/pcs

ACCIAIO AISI 304 - STEEL AISI 304

0,8	400	500	SPLS4050IL08	10
		1000	SPLS4010IL08	
	600	500	SPLS6050IL08	
		1000	SPLS6010IL08	



AL

**LAMIERE STIRATE
STRETCHED SHEETS**

Spessore Thickness T	Dimensioni Size W	Dimensioni Size H		Alluminio Aluminium	Quantità per conf. Pcs. box
mm	mm	mm	Cod. Art./Item Code	€/pz	pz/pcs

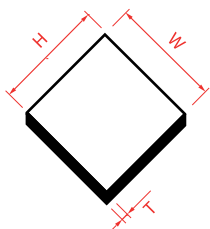
ALLUMINIO NATURALE - NATURAL ALUMINIUM

0,8	400	500	SPLS4050AN08	10
		1000	SPLS4010AN08	
	600	500	SPLS6050AN08	
		1000	SPLS6010AN08	



FE

**LAMIERE STIRATE
STRETCHED SHEETS**

Spessore Thickness T	Dimensioni Size W	Dimensioni Size H		Ferro Iron	Quantità per conf. Pcs. box
mm	mm	mm	Cod. Art./Item Code	€/pz	pz/pcs

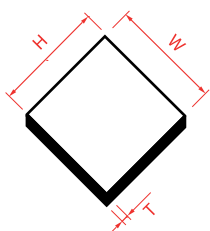
FERRO ZINCATO - GALVANIZED IRON

0,8	400	500	SPLS4050FZ08	10
		1000	SPLS4010FZ08	
	600	500	SPLS6050FZ08	
		1000	SPLS6010FZ08	

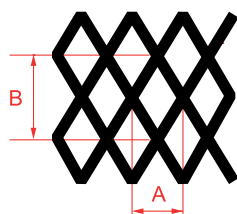
 Ax B 6x10 Alluminio/Aluminium
 Ax B 8x16 Acciaio/Steel



SPECIAL
PROFILES

Sistemi espositivi e proposte di Vendita

Display systems and sales proposals



Special Profiles

Tutti gli espositori Special Profiles sono studiati per offrire la massima visibilità dei prodotti e nel contempo ridurre al minimo gli ingombri. Anche la funzionalità è quanto di meglio si possa trovare sul mercato, per la semplicità con cui i vari profili si possono estrarre e reinserire. Spazi predefiniti e guidati, sia meccanicamente che tramite icone, permettono di avere tutti gli espositori facilmente e sempre in ordine. Abbondanti esempi di utilizzo facilitano la perfetta comprensione del contenuto. Tutti gli espositori sono modulari, potendo creare in maniera flessibile la propria esposizione, in funzione delle varie esigenze e disponibilità di spazio.

Infine grazie al loro design è possibile collocarli anche in ambienti spiccatamente eleganti, come una show room, impreziosendo l'ambiente.

Special Profiles

All Special Profiles displays are designed to offer maximum product visibility and at the same time reduce the overall dimensions. Functionality is also the best you can find on the market, for the simplicity with which the various profiles can be extracted and reinserted. Predefined and guided spaces, both mechanically and through icons, allow all displays to be easily and always in order. Many examples of use facilitate the perfect understanding of the content. All display units are modular, being able to flexibly create their own area, according to the various needs and space availability.

Finally, thanks to their design, they can also be placed in distinctly elegant environments, such as a show room, enhancing the environment.

FAI DA TE / DIY

BIG 2

BIG 3

PROFIL/PROFILES

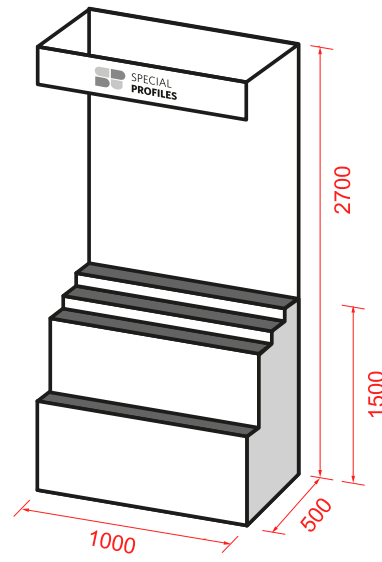
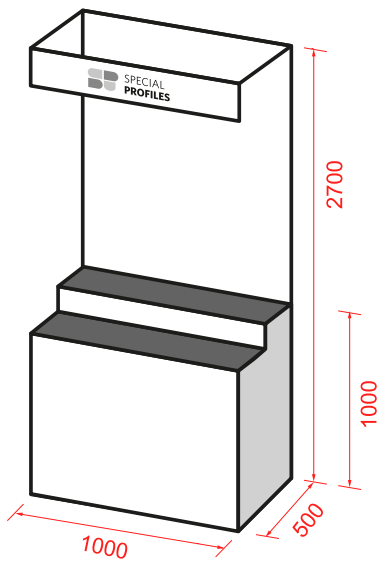

CERAMICA, EDILIZIA / TILES, BUILDING SYSTEMS





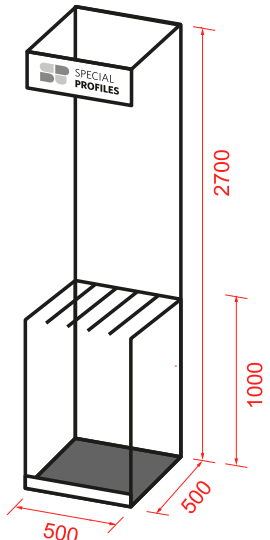
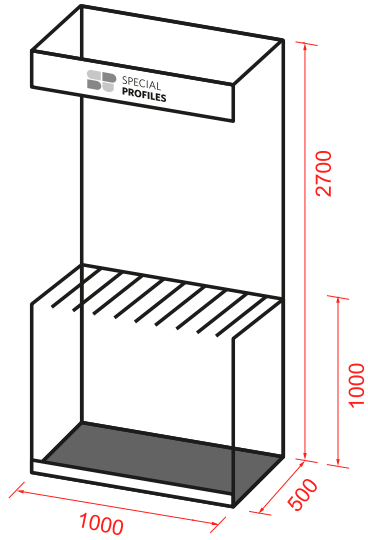

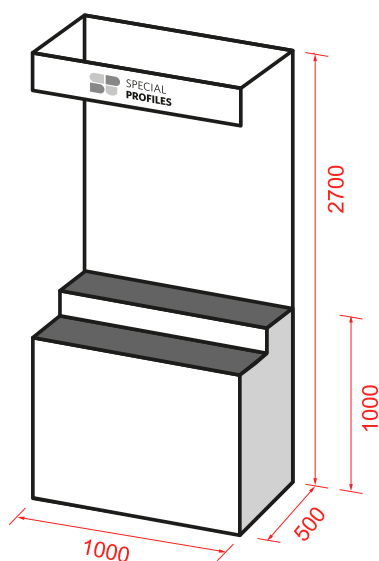
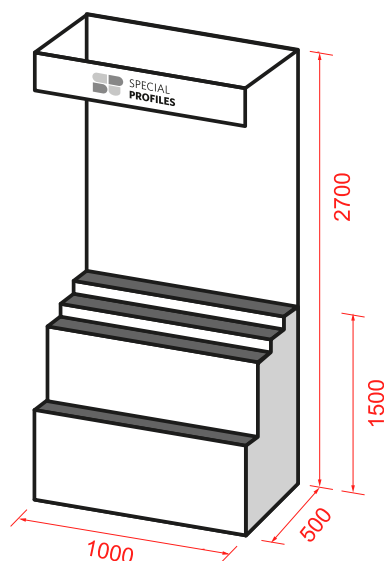



BIG TILE

SMALL TILE



PROPOSTA FAI DA TE ALLUMINIO *ALUMINIUM DIY PROPOSALS*
BIG 2

BIG 3

	pz / tipo pcs / type	Tot. referenze Total of references	Tot. barre Total of Lengths	Codice proposta Barre 2 mt Proposal code 2 m Lengths	Prezzo Price €	Codice proposta Barre 1 mt Proposal code 1 m Lengths	Prezzo Price €
Alluminio naturale <i>Natural aluminium</i>	20	29	580	SPANA2G		SPANA1G	
Alluminio anodizzato argento <i>Silver anodized aluminium</i>	20	29	580	SPAAA2G		SPAAA1G	
Alluminio brillante <i>Silver bright anodized aluminium</i>	20	29	580	SPABA2G		SPABA1G	

									
10x2 20x2 30x2 40x2 50x2	10x10 20x20 30x30 40x40 50x50	20x10 30x15 40x10	8x8 10x10 15x15 20x20	20x18	10x1 12x1 16x1 20x1 24x1	20x10 30x15	20x20	10x10	20x20 30x15
5	5	3	4	1	5	2	1	1	2

PROPOSTA FAI DA TE ACCIAIO *S-STEEL DIY PROPOSALS*

BIG 2

BIG 3

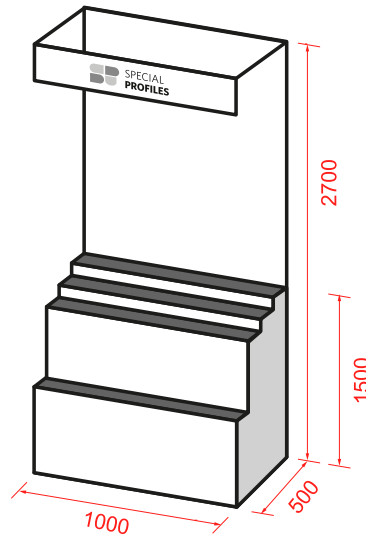
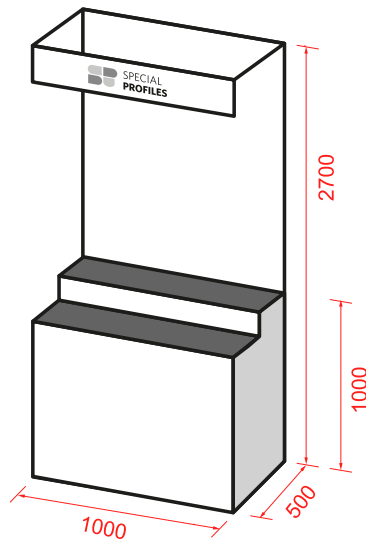





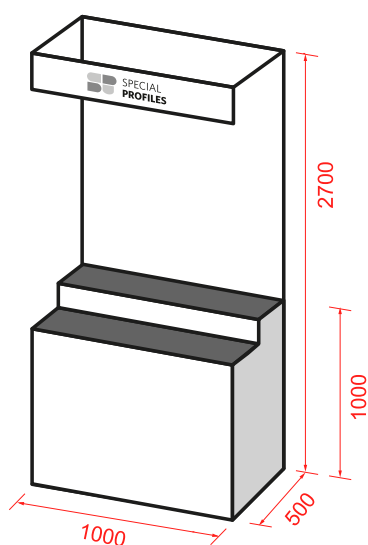
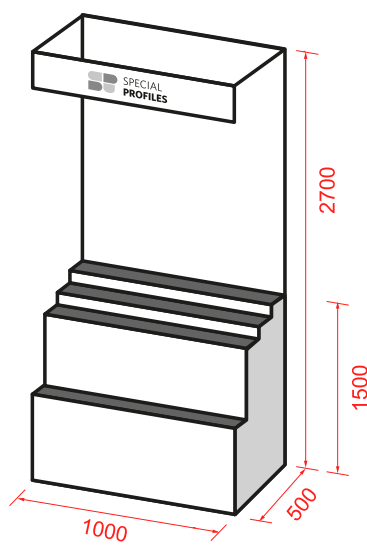





	pz / tipo pcs / type	Tot. referenze Total of references	Tot. barre Total of Lengths	Codice proposta Barre 2 mt Proposal code 2 m Lengths	Prezzo Price €	Codice proposta Barre 1 mt Proposal code 1 m Lengths	Prezzo Price €
Acciaio Steel	20	16	320	SPIL2G		SPIL1G	

10x0,7 20x0,7 30x0,7 40x0,7 50x0,7	10x10x0,7 20x20x0,7 30x30x0,7 40x40x0,7 50x50x0,7	20x10x0,7 30x20x0,7 40x10x0,7	10x15x0,7 15x15x0,7 20x20x0,7
5	5	3	3

PROPOSTA FAI DA TE FERRO *IRON DIY PROPOSALS*
BIG 2

BIG 3



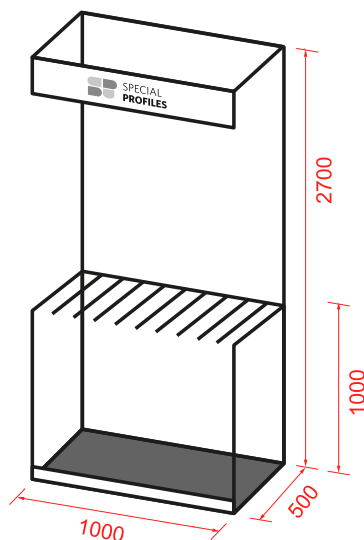







	pz / tipo pcs / type	Tot. referenze Total of references	Tot. barre Total of Lengths	Codice proposta Barre 2 mt Proposal code 2 m Lengths	Prezzo Price €	Codice proposta Barre 1 mt Proposal code 1 m Lengths	Prezzo Price €
Ferro <i>Iron</i>	12	24	288	SPFE2G		SPFE1G	





									
20x3 30x3 40x4 50x5	20x20x3 30x30x3 40x40x3	30x20x4 40x20x4	15x15x1,5 30x20x1,5	10 12	16x1,2 20x1,2 25x1,2 30x1,5	30x20x1,5 40x20x1,5	20x20x1,5 30x30x1,5	8x8 12x12	25x25x4
4	3	2	2	2	4	2	2	2	1

PROPOSTA CERAMICA, EDILIZIA
TILE, BUILDINGS SYSTEMS PROPOSALS
BIG TILE

Rivestimenti Mix <i>Mix Coverings</i>	pz / tipo <i>pcs / type</i>	Tot. referenze <i>Total of references</i>	Tot. prodotti <i>Total of Lengths</i>	Lunghezza Barre <i>Bar's Length</i> m	Codice proposta <i>Proposal code</i>	Prezzo <i>Price</i> €
--	--------------------------------	--	--	--	---	------------------------------------

Rivestimenti Mix <i>Mix Coverings</i>	20	25	500	mix	SPRIV2B	
--	----	----	-----	-----	---------	--

PVC bianco <i>PVC white</i>	PVC bianco <i>PVC white</i>	Alluminio <i>Aluminium</i>	Alluminio <i>Aluminium</i>	Acciaio <i>S-Steel</i>	Acciaio <i>S-Steel</i>	Alluminio <i>Aluminium</i>	Alluminio <i>Aluminium</i>	Acciaio <i>S-Steel</i>	Acciaio <i>S-Steel</i>
									
10 12	10 12	10 12	10 12	10 12	10 12	10 12	10 12	10 12	10 12
2	2	2	2	2	2	2	2	2	2

PVC bianco <i>PVC white</i>	PVC marrone <i>Brown PVC</i>	Alluminio <i>Aluminium</i>	Acciaio <i>S-Steel</i>	Acciaio <i>S-Steel</i>
				
22x22	28x28	25x25	30x30	30x30
1	1	1	1	1





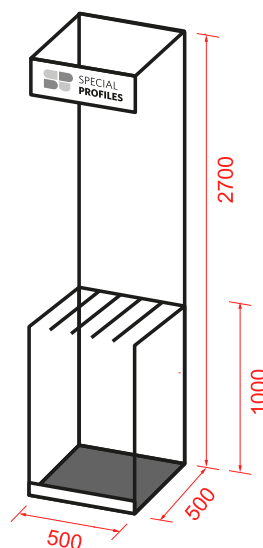





PROPOSTA CERAMICA, EDILIZIA
 TILE, BUILDINGS SYSTEMS PROPOSALS





SMALL TILE



	pz / tipo pcs / type	Tot. referenze Total of references	Tot. prodotti Total of Lengths	Lunghezza Barre Bar's Length m	Codice proposta Proposal code	Prezzo Price €
--	-------------------------	---------------------------------------	-----------------------------------	--------------------------------------	----------------------------------	----------------------

Rivestimenti Mix <i>Mix Coverings</i>	20	15	300	mix	SPRIV2S	
---	----	----	-----	-----	---------	--



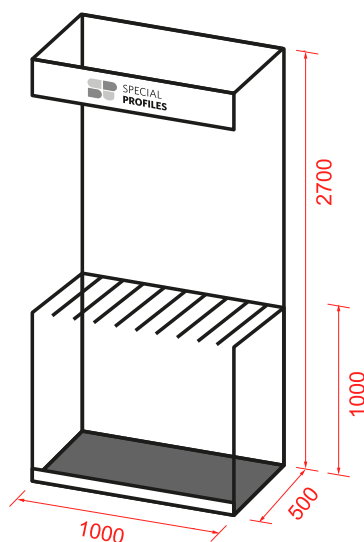

PVC bianco PVC white	PVC bianco PVC white	Alluminio Aluminium	Alluminio Aluminium	Acciaio S-Steel	Acciaio S-Steel	Alluminio Aluminium	Alluminio Aluminium	Acciaio S-Steel	Acciaio S-Steel
									
10	10	10	10	10	10	10	10	10	10
1	1	1	1	1	1	1	1	1	1







PVC bianco PVC white	PVC marrone Brown PVC	Alluminio Aluminium	Acciaio S-Steel	Acciaio S-Steel
				
22x22	28x28	25x25	30x30	30x30
1	1	1	1	1

PROPOSTA CERAMICA, EDILIZIA
TILE, BUILDING SYSTEMS PROPOSALS
BIG TILE









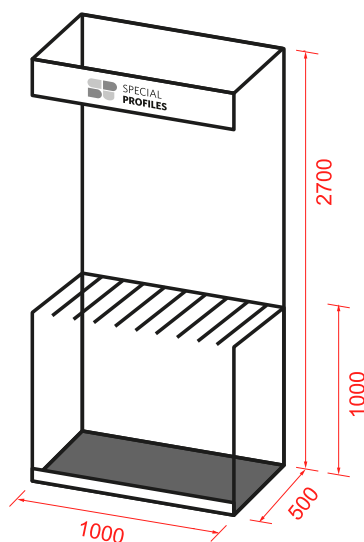







	pz / tipo pcs / type	Tot. referenze Total of references	Tot. prodotti Total of Lengths	Lunghezza Barre Bar's Length m	Codice proposta Proposal code	Prezzo Price €
--	-------------------------	--	--------------------------------------	--------------------------------------	----------------------------------	----------------------

Rivestimenti PVC <i>PVC Coverings</i>	30	19	570	mix	SPJJ2B	
---	-----------	-----------	------------	------------	---------------	--

bianco white	avorio ivory	rosa pink	grigio grey	celeste light blue	rosa marmor. marbled pink	rosa pesca peach pink	beige chiaro light beige	beige sabbia sand beige	beige tabacco tobacco beige
									
6-8-10-12	10	10	10	10	10	10	10	10	10
4	1	1	1	1	1	1	1	1	2

travertino grigio travertine grey	crema yellow cream	travertino beige travertine beige	travertino beige travertine beige	verde brasil brazil green	grigio grey
					
10	10	10	10	10	10
1	1	1	1	1	1





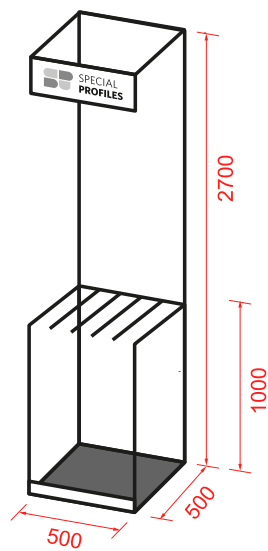



PROPOSTE PAVIMENTO ALLUMINIO, ACCIAIO
ALUMINIUM, S-STEEL FLOOR PROPOSALS
BIG TILE









	pz / tipo pcs / type	Tot. referenze Total of references	Tot. prodotti Total of Lengths	Lunghezza Barre Bar's Length m	Codice proposta Proposal code	Prezzo Price €	
Pavimento Floor	20	27	540	mix	SPFL2B		
alluminio argento silver aluminium	alluminio argento silver aluminium	alluminio argento silver aluminium	all. argento + brillante bright + silver al.	all. argento + brillante bright + silver al.	acciaio s-steel	arg. + brillante bright + silver al.	all. nat. + arg. + brillante natural + bright + silver al.
							
42x26	12,5	12,5	30	25	25	20x9	5x25
1	1	1	2	2	1	2	3
all. argento + brillante bright + silver al.	acciaio s-steel	alluminio argento silver aluminium	acciaio s-steel	all. argento + brillante bright + silver al.	acciaio s-steel	acciaio s-steel	
							
8-10-12,5	10-12,5	10	10	12,5	12,5	10	
6	2	1	1	2	1	1	

PROPOSTE PAVIMENTO ALLUMINIO, ACCIAIO
ALUMINIUM, S-STEEL FLOOR PROPOSALS
SMALL TILE

	pz / tipo pcs / type	Tot. referenze Total of references	Tot. prodotti Total of Lengths	Lunghezza Barre Bar's Length m	Codice proposta Proposal code	Prezzo Price €
--	-------------------------	--	--------------------------------------	--------------------------------------	----------------------------------	----------------------

Pavimento Floor	20	17	340	mix	SPFL2S	
----------------------------	-----------	-----------	------------	------------	---------------	--

alluminio argento silver aluminium	alluminio argento silver aluminium	alluminio argento silver aluminium	all. argento silver al.	all. argento silver al.	acciaio s-steel	all. argento silver al.	all. argento silver al.
							
42x26	12,5	12,5	30	25	25	20x9	5x25
1	1	1	1	1	1	1	1

all. argento silver al.	acciaio s-steel	alluminio argento silver aluminium	acciaio s-steel	all. argento silver al.	acciaio s-steel	acciaio s-steel	
							
10-12,5	10-12,5	10	10	12,5	12,5	10	
2	2	1	1	1	1	1	

Alluminio
Aluminium



Ferro
Iron



Profili per Ceramica
Tile profiles



Profili portaetichette
Label holder profiles



Descrizione etichetta
Label description

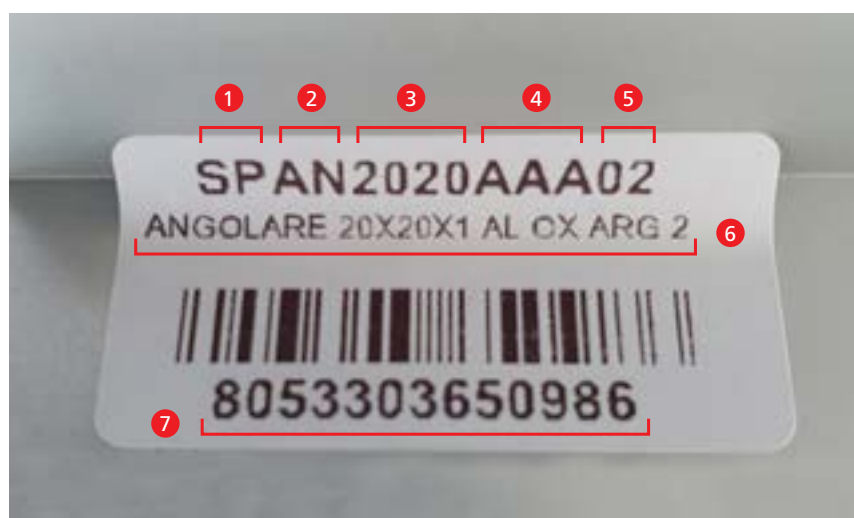

- 1- Codice azienda - *Company code*
- 2- Tipo prodotto - *Item type*
- 3- Misura prodotto - *Item size*
- 4- Finitura - *Finish*
- 5- Lunghezza profilo - *Item length*
- 6- Descrizione prodotto - *Item description*
- 7- Barcode EAN13 - *EAN13 code*

Principali caratteristiche delle materie prime utilizzate da Special Profiles

ALLUMINIO

Lega di alluminio (Al-Mg-Si)

I profili sono realizzati per estrusione oppure laminazione e successiva pressopiegatura.

Presentano ottima resistenza ai principali agenti chimici ed atmosferici.

Trattamenti superficiali tramite impianti di proprietà dell'azienda, trasformano il materiale in :

- Alluminio anodizzato: ossidazione anodica con 8-10 micron di spessore dell'ossido.
- Alluminio Brillantato: ossidazione anodica con 8-10 micron di spessore dell'ossido.
- Alluminio Verniciato: a polveri, con circa 100 micron di spessore della verniciatura.

Non consigliati per utilizzo a pavimento.

ACCIAIO INOX - AISI 304

I profili sono realizzati per laminazione e successiva pressopiegatura.

Presentano ottima resistenza ai principali agenti chimici ed atmosferici e ottima resistenza meccanica

Trattamenti superficiali tramite impianti proprietari dell'azienda, trasformano il materiale in :

Acciaio Lucido e Brillante.

Utilizzo sia a parete che a pavimento, in ambiente ospedaliero, alimentare, etc.

- Attenzione: i bordi di taglio non sono inossidabili

PVC Rigido (Paraspigoli)

Cloruro di vinile rigido esente da piombo, antiurto, autoestingente.

Buona resistenza meccanica e all'abrasione.

PVC Co-estruso - Rigido/Morbido (Giunti di dilatazione)

Cloruro di vinile rigido coestruso con PVC morbido esente da piombo, antiurto, autoestingente.

Ottima resistenza meccanica, all'abrasione.

PE-HD (Distanziatori per mattonelle)

Polietilene ad alta densità, resina termoplastica, ottima stabilità chimica e resistenza meccanica. L'alta densità(HD) aumenta la sua rigidità.

POLIPROPILENE (Angoli esterni quadrati e tondi)

Polimero termoplastico, semicristallino, con buona resistenza meccanica e all'abrasione.

Manutenzione

Evitare il contatto diretto con cemento e suoi derivati, se umidi, prodotti decalcificanti e detergenti che contengono cloro.

Evitare l'uso di prodotti abrasivi che possano graffiare (spugne abrasive/pagiette metalliche).

Subito dopo la posa procedere con una accurata pulizia delle superfici con abbondante acqua/prodotti a PH neutro/ non alcalini, in particolare rimuovere cemento, colla dalle superfici in vista.

Misure e tolleranze

Tutte le informazioni ed i disegni contenuti nel presente catalogo hanno carattere non impegnativo e soggette a variazione, senza preavviso.

Tutti i dati dimensionali fanno riferimento a quote nominali, soggette a tolleranze meccaniche, secondo la norma En-22768 ISO-2768 -m.

**Main characteristics of the raw materials used
by Special Profiles****ALUMINUM**

Aluminum alloy (Al-Mg-Si)

The profiles are made by extrusion or lamination and subsequent press bending.

They have excellent resistance to the main chemical and atmospheric agents.

Surface treatments through the company's proprietary systems, transform the material into:

Anodized aluminum: anodic oxidation with 8-10 microns of oxide thickness.

Polished Aluminum: anodic oxidation with 8-10 microns of oxide thickness.

Painted Aluminum: powder coated, with about 100 microns of paint thickness.

Not recommended for floor use.

STAINLESS S-STEEL - AISI 304

The profiles are made by rolling and subsequent press bending.

They have excellent resistance to the main chemical and atmospheric agents and excellent mechanical resistance

Surface treatments through the company's systems, transform the material into:

Polished and bright s-steel.

Use both on the wall and on the floor; in hospitals, food, industry.

- Attention: the cutting edges are not stainless

Rigid PVC (Corner protectors)

Lead-free, impact-resistant, self-extinguishing rigid vinyl chloride.

Good mechanical and abrasion resistance.

Co-extruded PVC - Rigid / Soft (expansion joints)

Co-extruded rigid vinyl chloride with soft PVC, lead-free, shockproof, self-extinguishing.

Excellent mechanical resistance, to abrasion.

PE-HD (Tile spacers)

High density polyethylene, thermoplastic resin, excellent chemical stability and mechanical resistance. The high density (HD) increases its stiffness.

POLYPROPYLENE (External square and round corners)

Thermoplastic polymer; semi-crystalline, with good mechanical and abrasion resistance.

Maintenance

Avoid direct contact with concrete and its derivatives, if wet, descaling products and detergents that contain chlorine.

Avoid using abrasive products that can scratch (abrasive sponges / metal wool).

Immediately after laying proceed with a thorough cleaning of the surfaces with plenty of water / neutral / non-alkaline PH products, in particular remove cement, glue from the exposed surfaces.

Measures and tolerances

All information and drawings contained in this catalog are non-binding and subject to change without notice. All dimensional data refer to nominal dimensions, subject to mechanical tolerances, according to the En-22768 ISO-2768 -m standard.

Condizioni generali di vendita

General conditions of sale

Sezione 1 - Condizioni Generali

- (1) I seguenti termini e condizioni generali di contratto si applicano per tutti i beni e servizi forniti a una specifica commessa, una persona giuridica di diritto pubblico o di un fondo speciale di diritto pubblico.
- (2) Se un cliente ha termini e condizioni di vendita diverse dalle nostre, e queste ultime non sono state esplicitamente loro riconosciute, le stesse sono da ritenersi non vincolanti per Mecc.AI, anche se non esplicitamente respinte.
- (3) L'acquisizione e l'interpretazione di questi termini e condizioni di vendita generali devono essere esclusivamente disciplinati dalla legge Italiana, così come la conclusione e l'interpretazione dei negozi giuridici con il cliente. L'applicazione della legge delle Nazioni Unite sulle vendite (CISG) è espressamente rifiutata.
- (4) La nullità di singole disposizioni o elementi di questi termini e condizioni di vendita generali non pregiudica la validità delle restanti disposizioni.
- (5) Il luogo di adempimento per gli obblighi creati direttamente o indirettamente dal rapporto contrattuale, compreso l'obbligo di rendere il pagamento, sarà la nostra sede aziendale.
- (6) L'esclusivo foro competente è quello in cui si trova la nostra sede aziendale.

Sezione 2 - Quotazioni, ambito di prestazione e stipula del contratto

- (1) Le nostre quotazioni generate e pertinenti ad uno specifico contratto sono soggette a possibili modifiche senza preavviso. Gli ordini sono per noi vincolanti solo nella misura in cui vengono confermati. Qualsiasi tipo di diverso accordo verbale è da ritenersi valido soltanto se confermato per iscritto.
- (2) La nostra conferma d'ordine ha il solo valore di definire la tipologia delle prestazioni contrattualmente dovute.
- (3) Ci riserviamo il diritto di modificare il progetto, la scelta dei materiali, le specifiche dello stesso ed il metodo di costruzione, anche dopo l'invio al cliente della conferma d'ordine, a condizione che tali modifiche non siano in contraddizione né con la conferma d'ordine né con le specifiche del cliente.
- (4) I documenti su cui la quotazione o la conferma d'ordine si basano, quali diagrammi e disegni, dimensioni e dichiarazioni di peso sono, di regola, solo approssimazioni e pertanto non sono vincolanti, purché non espressamente dichiarato per iscritto.
- (5) Sono ammesse consegne parziali.
- (6) Il nostro obbligo di fornitura è sospeso dal momento in cui il cliente risulta inadempiente agli obblighi presi.
- (7) In caso di commesse in conto lavoro, il cliente è tenuto a fornirci tutto il materiale e le documentazioni tecniche necessarie per la fornitura nei dovuti tempi e a proprie spese. Il materiale deve essere perfetto e rispettare i valori specifici indicati e possedere i sovrametalli normali nel settore. Il cliente si assume la responsabilità per le condizioni di garanzia e qualità del materiale fornitoci in conto lavoro. Si accolla inoltre i costi e le eventuali perdite aggiuntive sostenute da Mecc.AI a causa di materiale non avente le dovute caratteristiche tecniche e di qualità garantite.

Sezione 3 - prezzi, termini e condizioni di pagamento

- (1) I prezzi applicati, se non diversamente specificato per iscritto in quotazione o conferma d'ordine, sono da intendersi franco fabbrica, escludendo gli altri costi di spedizione e di trasporto. Se la consegna è concordata con incluso il trasporto, i prezzi indicati da noi relativi al trasporto stesso si basano sulle spese e le altre variabili pertinenti in vigore al momento della quotazione. I prezzi potranno di conseguenza variare, a favore o sfavore del cliente, al variare di queste condizioni nel lasso di tempo che intercorre tra la quotazione e la spedizione del materiale ordinato, senza che il cliente abbia alcun diritto di recedere dal contratto per questo motivo.
- (2) Se trascorrono più di quattro mesi tra la firma del contratto e la consegna dei materiali ordinati, senza che sussistano responsabilità da parte di Mecc.AI per il ritardo nella consegna, il prezzo dei materiali ordinati potrà aumentare a seconda del caso prendendo in considerazione i costi della materia prima, gli stipendi ed eventuali altri costi accessori sostenuti da Mecc.AI in questo lasso di tempo. Se il prezzo di acquisto aumenta di oltre il 30%, il cliente ha il diritto di recedere dal contratto.
- (3) Se dovessero pervenire richieste di modifica ai materiali ordinati da parte del cliente, i costi aggiuntivi sostenuti a seguito di queste modifiche verranno addebitati e fatturati al cliente.
- (4) Le nostre fatture devono essere saldate per intero in base alle condizioni contrattuali di pagamento concordate tra le parti ed indicate in fattura.
- (5) Se il cliente supera la data di pagamento concordata, Mecc.AI si riserva il diritto di pretendere interessi passivi pari a 8 punti % superiori al tasso bancario in vigore in quel momento.
- (6) Se l'acquirente è in ritardo sul pagamento e presunti giustificati dubbi sulla sua capacità di pagare la somma di nostra proprietà a titolo di credito diventano evidenti, Mecc.AI, indipendentemente da altri nostri diritti, è autorizzata ad esigere il pagamento in anticipo per ulteriori nuove consegne allo scopo di rendere tutti i nostri crediti derivanti dal rapporto commerciale pagabili immediatamente.

Sezione 4 - Spedizione

Il carico dei materiali ordinati e la spedizione degli stessi sono effettuati senza assicurazione e a rischio del destinatario. Eventuali costi aggiuntivi derivanti da condizioni particolari non preventivamente concordate saranno a carico del compratore - anche se i termini di consegna concordati includono il trasporto.

Sezione 5 - Termini di consegna

- (1) La definizione dei tempi di consegna deve essere considerata non vincolante per Mecc.AI. La

produzione deve essere comunque eseguita al meglio delle nostre conoscenze e competenze e può essere prolungata a seconda dei casi, in particolare nel caso in cui l'acquirente si astenga dal fornire la sua necessaria e concordata assistenza. Lo stesso vale per le misure adottate in risposta alle loro controversie, in particolare nel caso in cui eventi imprevisi fuori dal nostro controllo dovessero verificarsi; scioperi e serrate, ritardi nelle consegne di componenti da un nostro fornitore, imprevisi derivanti dal trasporto e da interruzioni operative, carenza di materia prima, interruzioni di corrente, ecc.

- (2) Modifiche fatte ai materiali ordinati su specifica richiesta del cliente generano di conseguenza un congruo posticipo della data di consegna concordata.

Sezione 6 - trasferimento del rischio

(1) Il rischio di perdita accidentale o deterioramento del materiale ordinato passa al cliente non appena il materiale stesso viene prodotto e ne viene data comunicazione al cliente.

Sezione 7 - Riserva di proprietà

- (1) Ci riserviamo il titolo di proprietà delle merci fornite fino a quando non sia stato effettuato il loro pagamento per intero. La riserva di proprietà si applica anche su tutti i crediti esistenti nel rapporto tra noi ed il cliente, compresi quelli pertinenti a materiali oggetto di reclamo, sino a che le controversie non siano dichiarate risolte ed il pagamento dei materiali oggetto di reclamo sia effettuato per intero.
- (2) Il cliente non è autorizzato a vendere o disporre in alcuna maniera del materiale oggetto dalla fattura di vendita non pagata, compreso cederlo in garanzia a terzi. Non è altresì autorizzato a rivendere tale materiale nel contesto di una propria transazione commerciale. Qualsiasi procedura esecutiva promossa da terzi che abbia per oggetto i materiali deve essere immediatamente portata a conoscenza di Mecc.AI.
- (3) In osservanza del diritto di proprietà come sopra previsto a favore di Mecc.AI, il cliente deve astenersi dal porre in essere atti o comportamenti tali da impedire a Mecc.AI il valido esercizio di tale diritto.
- (4) In caso di violazione dell'obbligazione del cliente come prevista dal presente articolo, Mecc.AI ha il diritto di revocare con effetto immediato tutti gli ordini dei materiali non ancora prodotti.

Sezione 8 - reclami in garanzia

- (1) In concomitanza con una transazione commerciale tra le due parti nel contesto del contratto, il cliente deve ispezionare il materiale immediatamente al momento della consegna, intendendo che ciò sia utile e funzionale al buon andamento della transazione. Nel caso venga riscontrato un difetto nei materiali forniti, il cliente ha l'obbligo di comunicarlo a Mecc.AI entro 8 giorni dal ricevimento dei materiali stessi. In assenza di comunicazione, il materiale viene considerato accettato, a meno che non si tratti di un difetto che non avrebbe potuto essere identificato durante l'ispezione iniziale.
 - (2) Nella misura in cui i beni hanno un difetto per il quale Mecc.AI è ritenuta responsabile, e il cliente ha notificato il difetto per iscritto in tempo utile, Mecc.AI si impegna a porre rimedio alla situazione (ed il cliente non ha il diritto di recedere dal contratto o ridurre il prezzo di acquisto) a meno che non venga espressamente dichiarato da Mecc.AI di rifiutare di porre rimedio a difetto sulla base delle norme di legge. Il cliente dovrà comunque concederci un ragionevole periodo di tempo per porre rimedio ad ogni difetto riscontrato. I materiali contestati possono essere altresì sostituiti con la fornitura di nuovi. Il prezzo di acquisto non può essere ridotto né può il cliente recedere dal contratto, mentre una azione di rimedio da parte di Mecc.AI è in corso.
 - (3) I diritti di garanzia vanno in prescrizione un anno dopo che le merci sono state consegnate.
- Prezzi:
I prezzi indicati nel listino Special Profiles sono in euro e non comprendono l'IVA. La fatturazione avviene al pezzo.

Confezioni di vendita

- 10 pz. su tutto, 5 pz. su lamiera, 6 pz. su ferro.

Sconfezionamento

- Maggiorazione del 10% sul listino in vigore.

Ordini

Specificare SEMPRE nei Vostri ordini l'unità di misura relativa alle quantità indicate. In mancanza di essa, verranno SEMPRE considerata in PEZZI.

Consegne

Dal pronto. Successive spedizioni parziali per mancanza di merce saranno in porto franco, purché l'importo sia superiore al minimo evadibile.

Reso merce:

I resi verranno accettati solo previa compilazione del modulo apposito e successiva autorizzazione da parte di Special Profiles.

Special Profiles a brand of Mecc.AI Group

Via dei Laghi, 4 - Calcinelli 61036 Colli al Metauro (PU) - Italia
Tel. +39.0721.8764.206
www.special-profiles.com

Section 1 - General Conditions

(1) The following general terms and conditions of contract apply for all goods and services provided to a specific job order, a legal person governed by public law or of a special fund under public law.

(2) If a customer has different terms and conditions of sale than ours, and these the latter have not been explicitly recognized to them, they are to be considered not binding on Mecc.Al, even if not explicitly rejected.

(3) The acquisition and interpretation of these terms and conditions of sale

Generals must be exclusively governed by Italian law, as well as the conclusion and interpretation of legal stores with the client. The application of the United Nations Sales Act (CISG) is expressly rejected.

(4) The nullity of individual provisions or elements of these terms and conditions of General sales do not affect the validity of the remaining provisions.

(5) The place of performance for obligations created directly or indirectly from the contractual relationship, including the obligation to make the payment, will be the our corporate headquarters.

(6) The exclusive place of jurisdiction is the one where our company headquarters are located.

Section 2 - Quotes, scope of performance and conclusion of the contract

(1) Our quotes generated and relevant to a specific contract are subject to possible changes without notice. Orders are binding on us only to the extent that they are confirmed. Any kind of different arrangement minutes are to be considered valid only if confirmed in writing.

(2) Our order confirmation has the only value of defining the typology of the contractually due services.

(3) We reserve the right to modify the design, the choice of materials, the specifications of the same and the method of construction, even after being sent to customer of the order confirmation, provided that these changes are not in contradiction neither with the order confirmation nor with the customer's specifications.

(4) The documents on which the quote or order confirmation are based, such as diagrams and drawings, dimensions and weight declarations are, as a rule, only approximations and therefore are not binding, as long as not expressly declared in writing.

(5) Partial deliveries are allowed.

(6) Our supply obligation is suspended from the moment the customer appears breach of obligations.

(7) In the case of subcontracting orders, the customer is obliged to provide us with all material and technical documentation necessary for the delivery in due times and own expense. The material must be perfect and respect the values specific indicated and possess the normal allowances in the sector. The customer assumes the responsibility for the conditions of guarantee and quality of the material supplied to us on account work. It also takes over the costs and any additional losses incurred by Mecc.Al because of material that does not have the necessary technical and quality characteristics Guaranteed.

Section 3 - prices, terms and conditions of payment

(1) The prices applied, unless otherwise specified in writing in the quotation or order confirmation, are to be understood ex works, excluding the other costs of shipping and transportation. If the delivery is agreed with including transportation, the prices indicated by us relating to the transport itself are based on expenses and others relevant variables in effect at the time of listing. Prices will be able to consequently vary, in favor or disadvantage of the customer, as these conditions vary in the time that elapses between the quotation and the shipment of the material ordered, without the customer having any right to withdraw from the contract for this reason.

(2) If more than four months elapse between the signing of the contract and the delivery of the materials ordered, without any liability on the part of Mecc.Al for the delay in delivery, the price of the materials ordered may increase depending of the case taking into consideration the costs of the raw material, the wages and any other ancillary costs incurred by Mecc.Al during this period. If the purchase price increases by more than 30%, the customer has the right to withdraw from contract.

(3) If requests for modification to the materials ordered by the customer, additional costs incurred as a result of these changes will be charged and billed to the customer.

(4) Our invoices must be paid in full according to the conditions payment agreements agreed between the parties and indicated on the invoice.

(5) If the customer exceeds the agreed payment date, Mecc.Al reserves the right to claim interest expense equal to 8% points higher than the current bank rate in that moment.

(6) If the buyer is late on the payment and suspected justified doubts about the his ability to pay the sum of our property by way of credit become evident, Mecc.Al, independently of our other rights, is authorized to demand payment in advance for further new deliveries for the purpose of making all our trade credit claims payable immediately.

Section 4 - Shipping

The loading of the ordered materials and their shipment are carried out without insurance and at the risk of the recipient. Any additional costs resulting from conditions details not previously agreed will be paid by the buyer - even if the agreed delivery terms include transportation.

Section 5 - Delivery terms

(1) The definition of delivery times must be considered non-binding for Mecc.Al. The production must however be performed to the best of our knowledge and skills and can be prolonged as appropriate, particularly in the in the event that the buyer refrains from providing his necessary and agreed assistance.

The same applies to the measures taken in response to their disputes, in particular in the event that unforeseen events beyond our control should occur; strikes e lockouts, delays in deliveries of components from one of our suppliers, unforeseen incidents from transport and operational interruptions, shortage of raw materials, interruptions of current, etc.

(2) Modifications made to the materials ordered upon specific customer request generate consequently a reasonable postponement of the agreed delivery date.

Section 6 - transfer of risk

(1) The risk of accidental loss or deterioration of the ordered material it passes to the customer as soon as the material itself is produced and it is communicated to the client.

Section 7 - Retention of title

(1) We reserve the title to the goods supplied until it has been paid in full. The retention of title also applies to everyone the credits existing in the relationship between us and the customer, including those pertinent to materials object of complaint, until disputes are declared resolved and payment of the materials subject to complaint is made in full.

(2) The customer is not authorized to sell or dispose of the in any way material covered by the unpaid sales invoice, including transferring it as guarantee to third parties. It is also not authorized to resell such material in the context of a own commercial transaction. Any executive procedure promoted by third parties who have as their object the materials must be immediately brought to knowledge of Mecc.Al.

(3) In compliance with the property right as provided above in favor of Mecc.Al, the customer must refrain from engaging in acts or conduct that would prevent a Mecc.Al the valid exercise of this right.

(4) In case of violation of the client's obligation as provided for in this article, Mecc.Al has the right to revoke all orders from materials not yet produced.

Section 8 - warranty claims

(1) In conjunction with a commercial transaction between the two parties in the context of the contract, the customer must inspect the material immediately at the time of delivery, meaning that this is useful and functional to the good performance of the transaction. If a defect is found in the materials supplied, the customer has the obligation to communicate it to Mecc.Al within 8 days of receipt of the materials themselves. In the absence of communication, the material is considered accepted, unless that it is not a defect that could not have been identified during the initial inspection.

(2) To the extent that the goods have a defect for which Mecc.Al is held responsible, and the customer has notified the defect in writing in good time, Mecc.Al undertakes to remedy the situation (and the customer has no right to withdraw from the contract or reduce the purchase price) unless it comes expressly declared by Mecc.Al to refuse to remedy a defect on the basis of the law. The customer will still have to give us a reasonable period of time to remedy any defect found. The materials disputed can also be replaced with the supply of new ones. The price of purchase cannot be reduced nor can the customer withdraw from the contract while a remedial action by Mecc.Al is in progress.

(3) Warranty claims become time-barred one year after the goods have been delivered.

Prices

Prices in Special Profiles price list are in euro, without VAT. Invoicing by piece.

Sales packaging

- 10 pcs. over all, 5 pcs. on sheets, 6 pcs. on iron.

Unpack

- 10% surcharge on the current price list.

Orders

ALWAYS specify in your orders the unit of measurement relating to the indicated quantities. In absence of it, they will ALWAYS be considered in PIECES.

Deliveries

From stock. Subsequent partial shipments for lack of goods will be free delivered provided that the amount is greater than the minimum executable amount.

Returned goods

Returns will be accepted only after completing the appropriate form and subsequent authorization by Special Profiles.

Special Profiles a brand of Mecc.Al Group

Via dei Laghi, 4 - Calcinelli 61036 Colli al Metauro (PU) - Italy
Tel. +39.0721.8764.206
www.special-profiles.com

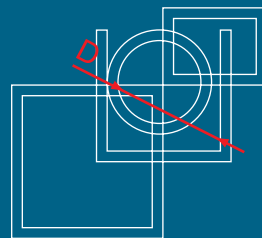

SPECIAL PROFILES

by **MECC.AL. Srl**

Via dei Laghi, 4 - Calcinelli 61036

Colli al Metauro - PU - Italy

Tel: + 39 0721 876 4201 (IT)

Tel: + 39 0721 876 4206 (EN)

specialprofiles@meccal.com



www.special-profiles.com